

2023
2024



SunnyVal
Garden & contract

18 AÑOS, GRACIAS A VOSOTROS



Ilusión, confianza y dedicación.

Año tras año, en Sunnyval Garden & Contract continuamos apostando por los productos más innovadores, adecuando nuestra oferta a la demanda continua de nuevos productos adaptados a las nuevas tendencias. Con nuestras tres premisas, ilusión, confianza, y dedicación, nos hemos convertido en un referente en el mercado Europeo de mobiliario de exterior. Ofrecemos la atención más personalizada y el mejor servicio a nuestros clientes, y apostamos por colecciones que crean espacios adaptados a todo tipo de ambientes. En este catálogo 2023-2024, presentamos los productos de mayor calidad a unos precios realmente competitivos.

En Sunnyval Garden & Contract ofrecemos, soluciones para todo tipo de espacios, sin descuidar la elegancia, la innovación y el estilo.



Illusion, trust and dedication.

Year after year, at Sunnyval Garden & Contract we continue to bet on the most innovative products, adapting our offer to the continuous demand for new products adapted to new trends. With our three premises, enthusiasm, trust, and dedication, we have become a benchmark in the European market for outdoor furniture. We offer the most personalized attention and the best service to our clients, and we bet on collections that create spaces adapted to all types of environments. In this 2023-2024 catalog, we present the highest quality products at truly competitive prices.

At Sunnyval Garden & Contract we offer solutions for all types of spaces, without neglecting elegance, innovation and style.



Plaisir, confiance et engagement.

Année après année, chez Sunnyval Garden & Contract, nous continuons à miser sur les produits les plus innovants, en adaptant notre offre à la demande continue de nouveaux produits adaptés aux nouvelles tendances. Avec nos trois locaux, l'enthousiasme, la confiance et le dévouement, nous sommes devenus une référence sur le marché européen du mobilier d'extérieur. Nous offrons l'attention la plus personnalisée et le meilleur service à nos clients, et nous misons sur des collections qui créent des espaces adaptés à tous types d'environnements. Dans ce catalogue 2023-2024, nous présentons des produits de la plus haute qualité à des prix vraiment compétitifs.

Chez Sunnyval Garden & Contract, nous proposons des solutions pour tous types d'espaces, sans négliger l'élégance, l'innovation et le style.



Illusion, Vertrauen und Hingabe.

Jahr für Jahr setzen wir bei Sunnyval Garden & Contract weiterhin auf die innovativsten Produkte und passen unser Angebot an die ständige Nachfrage nach neuen Produkten an, die an neue Trends angepasst sind. Mit unseren drei Prämissen, Begeisterung, Vertrauen und Engagement sind wir zu einem Maßstab auf dem europäischen Markt für Gartenmöbel geworden. Wir bieten unseren Kunden die persönlichste Aufmerksamkeit und den besten Service und setzen auf Kollektionen, die Räume schaffen, die an alle Arten von Umgebungen angepasst sind. In diesem Katalog 2023-2024 präsentieren wir Produkte von höchster Qualität zu wirklich wettbewerbsfähigen Preisen.

Bei Sunnyval Garden & Contract bieten wir Lösungen für alle Arten von Räumen, ohne dabei Eleganz, Innovation und Stil zu vernachlässigen.



15 ЛЕТ ПРОИЗВОДСТВА УЛИЧНОЙ МЕБЕЛИ.

Год за годом в Sunnyval Garden & Contract мы продолжаем делать ставки на самые инновационные продукты, адаптируя наше предложение к постоянному спросу на новые продукты, адаптированные к новым тенденциям. Благодаря нашим трем основным принципам, энтузиазму, доверию и преданности делу, мы стали эталоном на европейском рынке уличной мебели. Мы предлагаем нашим клиентам максимально индивидуальный подход и лучший сервис, а также делаем ставку на коллекции, которые создают пространства, адаптированные ко всем типам окружающей среды. В этом каталоге на 2023-2024 годы мы представляем продукцию высочайшего качества по действительно конкурентоспособным ценам.

В Sunnyval Garden & Contract мы предлагаем решения для всех типов помещений, не забывая об элегантности, новаторстве и стиле.







ORÍGENES

ALUMINIO ALUMINIUM 6-73

-Apolo	6	-New oslo	62
-Omi	14		
-Concept	18		
-Stryn	38		
-Isabelle	42		
-Antares	54		

Datos técnicos / Technical 220-245

CUERDA / TEXTIL

ROPE / TEXTILE 74-133

-Hadar	74	-Deneb	106
-Viken	80	-Borgen	120
-Vega	96	-L. Island	124
-Atra	100		
-Aioros	102		

Datos técnicos / Technical 246-261

TECA

TEAK 134-175

-Nirea	134	-Vernom	162
-Java	142	-Classic	168
-Edson	148		

Datos técnicos / Technical 262-275

RATTAN SINT.

WICKER 176-209

-Aurora	176	-Berlin	204
-Kurl	184	-Riviera	206
-Aven	192		
-Arvika	192		
-Melbourne	196		
-Seattle	198		
-Palma	200		

Datos técnicos / Technical 276-283

SOMBRILLAS / PÉRGOLAS

UMBRELLA / GAZEBO 210-213

-Pie central	210	-Pérgolas	213
-Pie lateral	212		

FUNDAS PROTECCIÓN

PROTECTION COVERS 214-218







































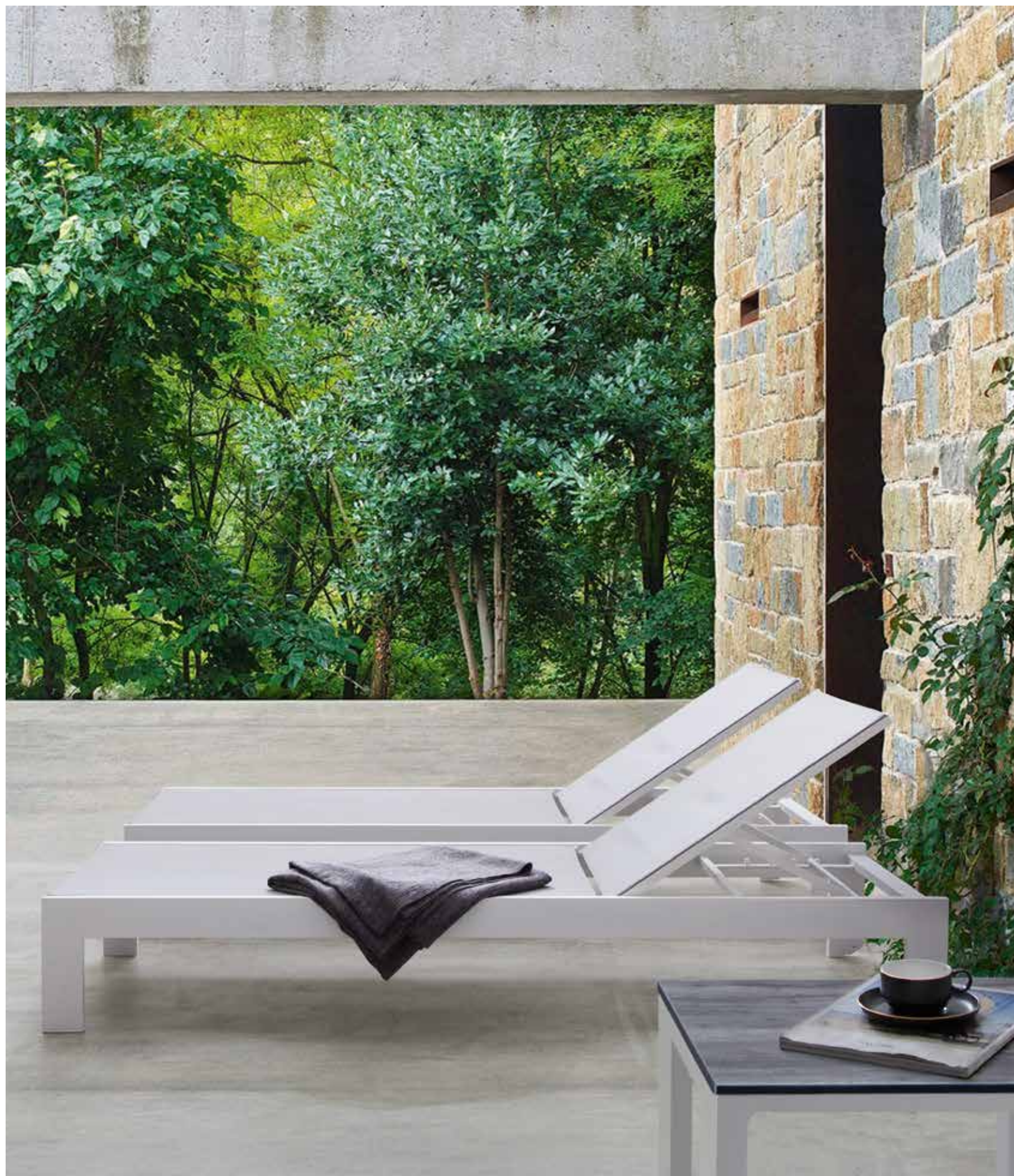



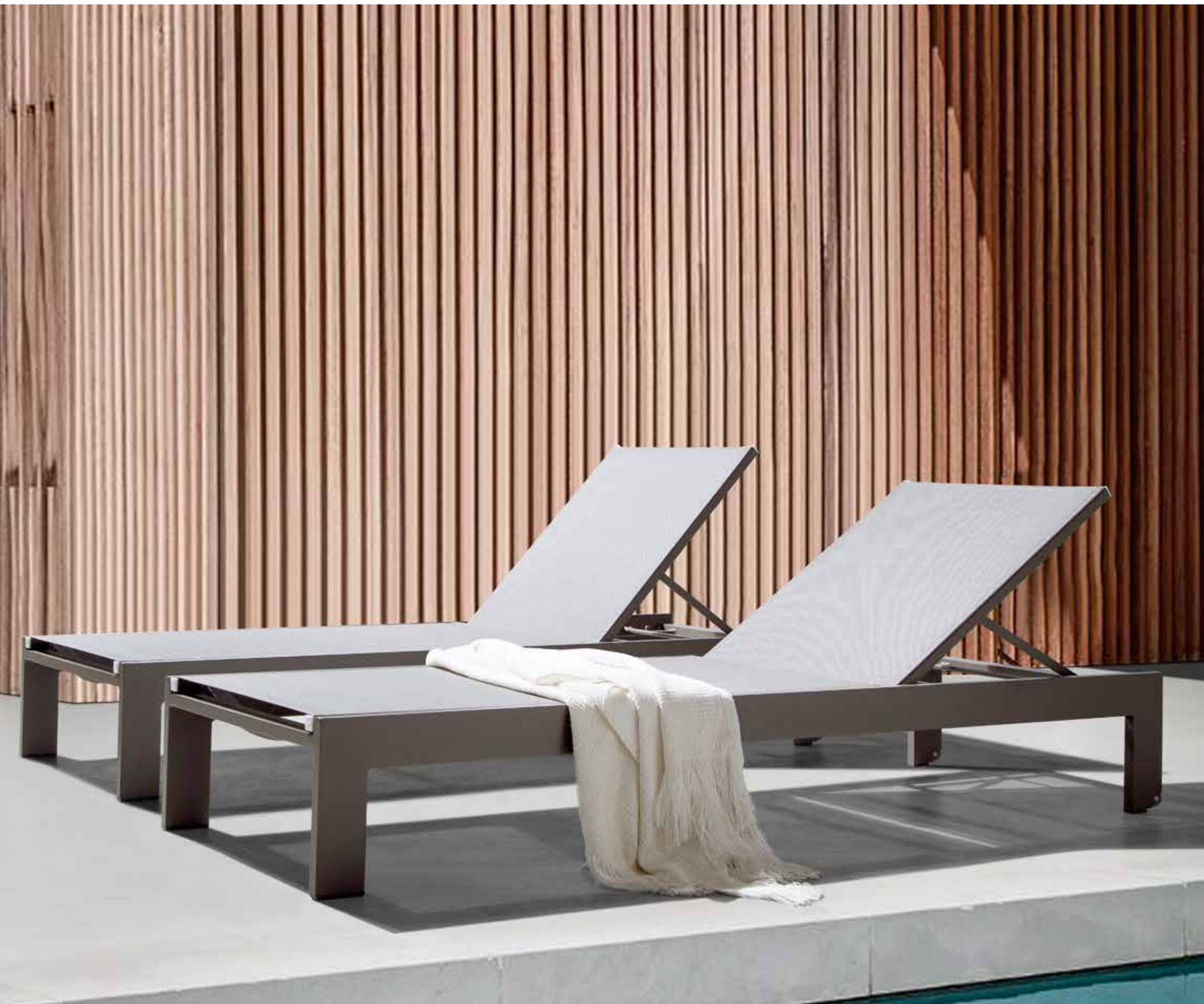

































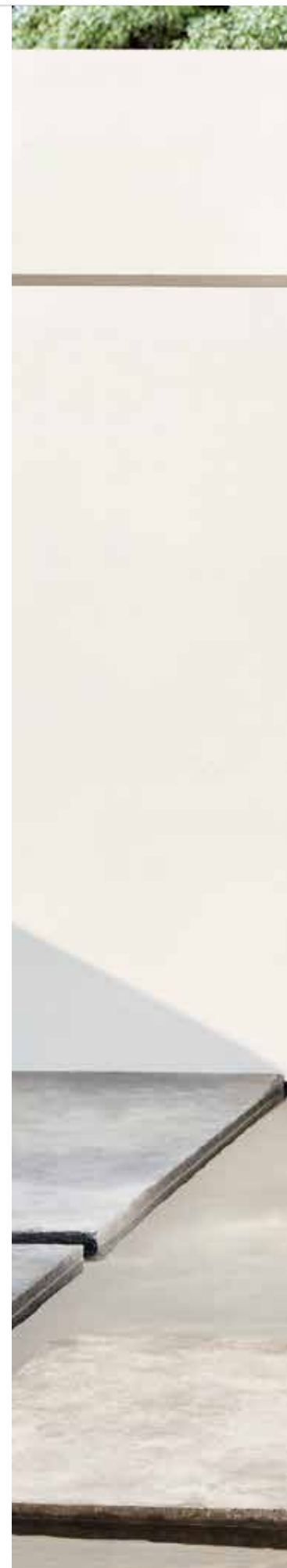

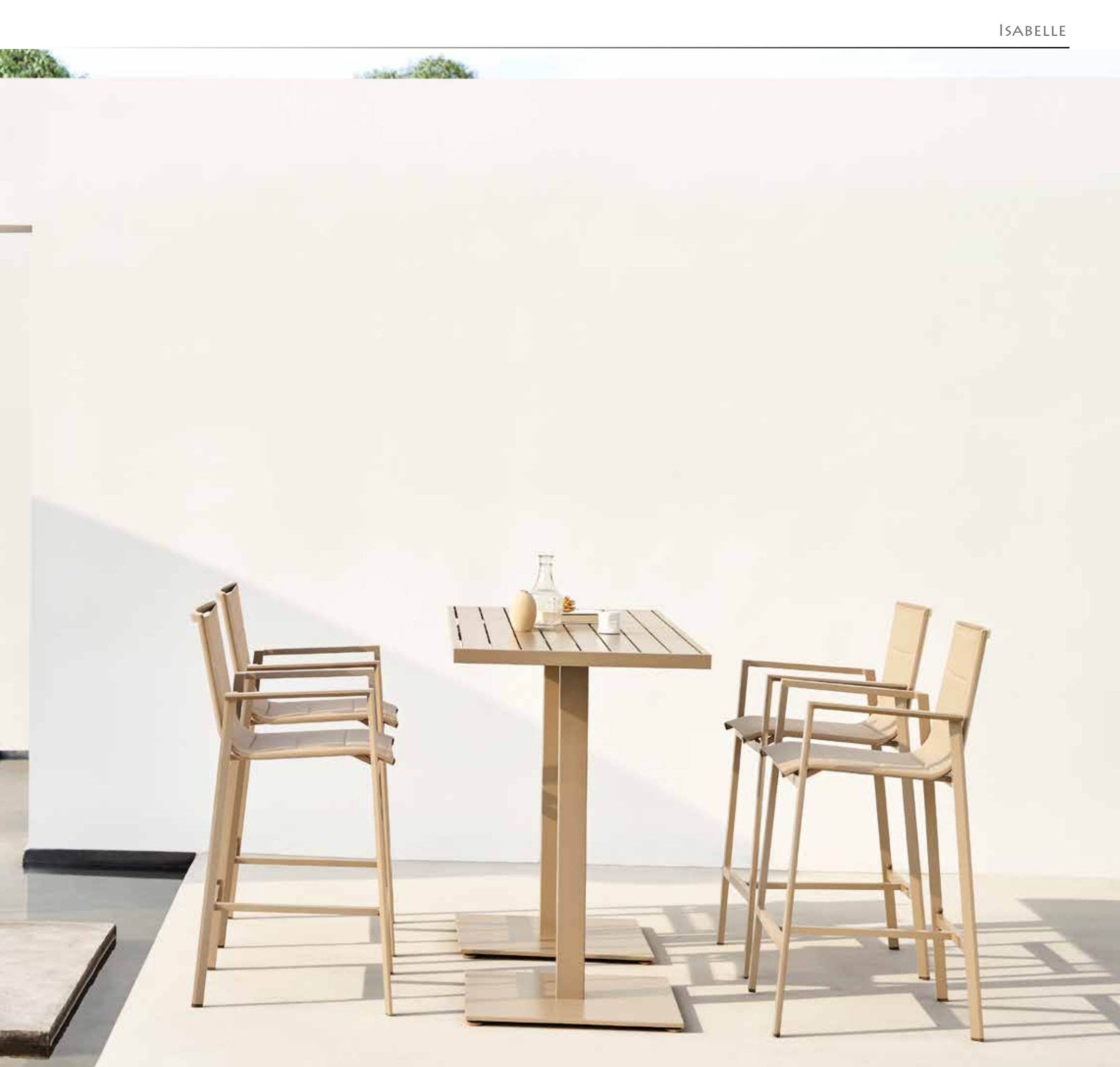





















































































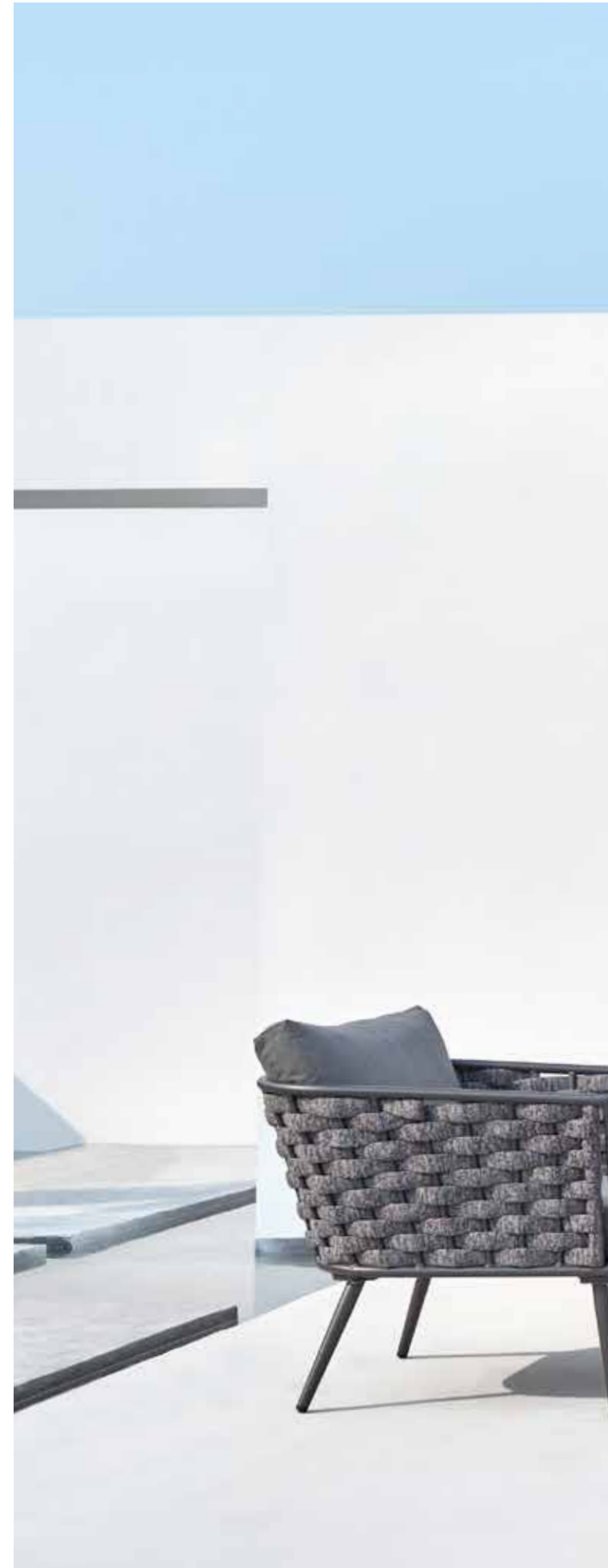













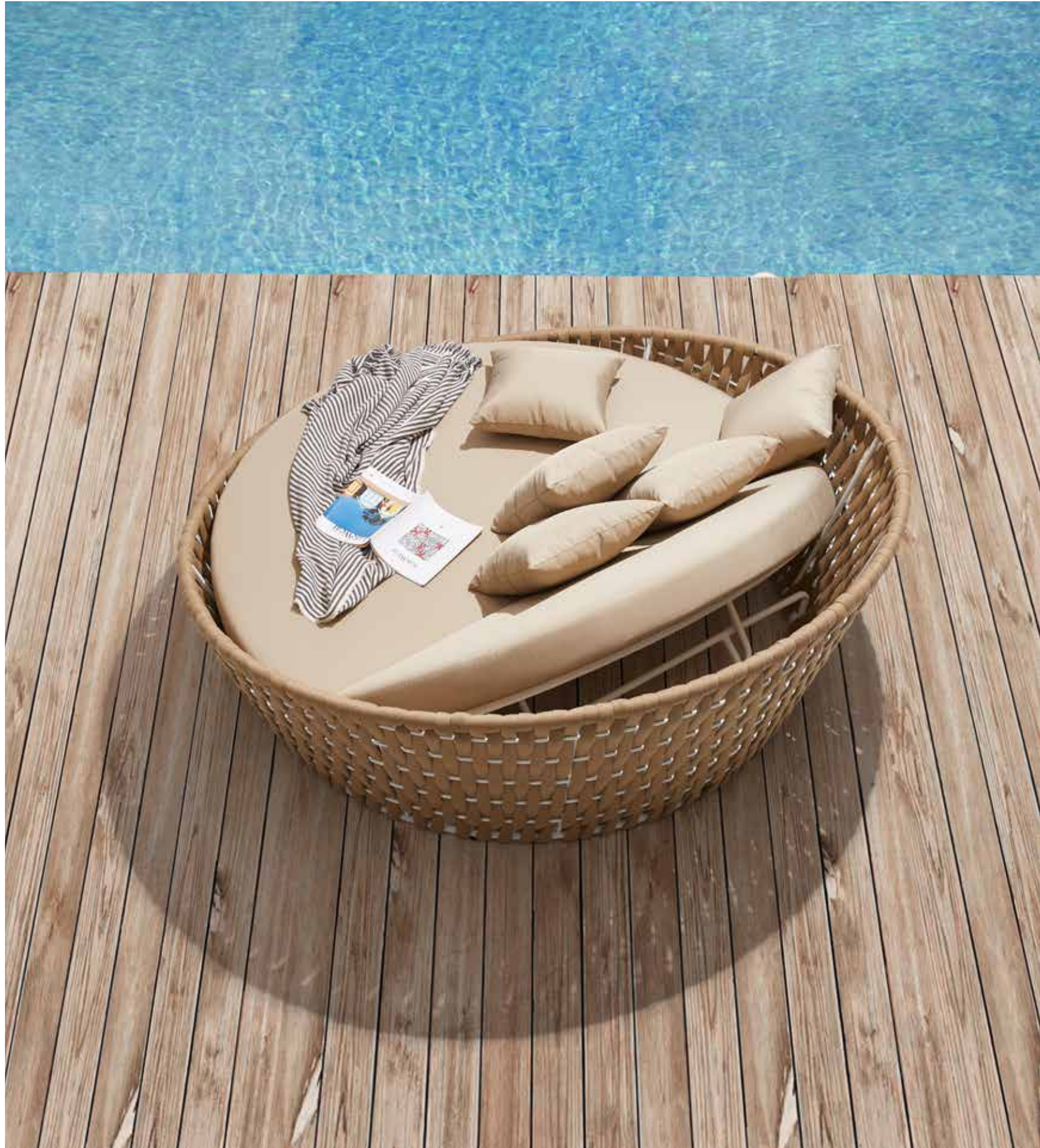





































































































































































































































Sombrilla exagonal Ø300cm. Sistema de apertura por manivela. Mástil divisible en 38mm color blanco. Cubierta en poliéster de 160g/m2 color crudo.



TM(cm)	PS(IN)	SA	OS
38,0	15,0	MANIVELA	CRANK
PN(kg)	NW(LB)	REF.(CODE)	PTOS (PT)
4,0	8,8	30500064	78



Sombrilla exagonal Ø300cm. Sistema de apertura por manivela. Mástil divisible en 38mm color blanco. Cubierta en poliéster de 160g/m2 color Amarillo.

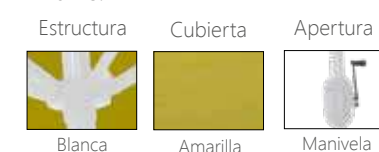

TM(cm)	PS(IN)	SA	OS
38,0	15,0	MANIVELA	CRANK
PN(kg)	NW(LB)	REF.(CODE)	PTOS (PT)
4,0	8,8	30500047	78

Sombrilla exagonal Ø270cm. Sistema de apertura por manivela. Mástil divisible en 38mm color blanco. Cubierta en poliéster de 160g/m2 color Azul.

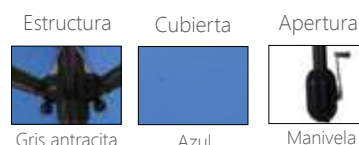

TM(cm)	PS(IN)	SA	OS
38,0	15,0	MANIVELA	CRANK
PN(kg)	NW(LB)	REF.(CODE)	PTOS (PT)
4,0	8,8	30500073	78



Sombrilla exagonal Ø300cm. Sistema de apertura por manivela. Mástil divisible en 38mm color blanco. Cubierta en poliéster de 160g/m2 color blanco.

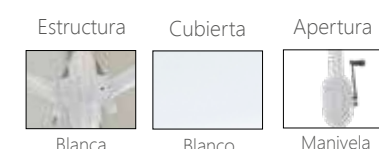

TM(cm)	PS(IN)	SA	OS
38,0	15,0	MANIVELA	CRANK
PN(kg)	NW(LB)	REF.(CODE)	PTOS (PT)
4,0	8,8	30500074	78

Sombrilla exagonal Ø300cm. Sistema de apertura por manivela. Mástil divisible en 38mm color blanco. Cubierta en poliéster de 160g/m2 color granate.

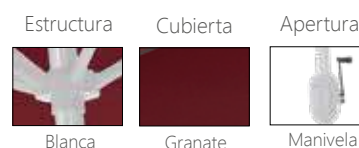

TM(cm)	PS(IN)	SA	OS
38,0	15,0	MANIVELA	CRANK
PN(kg)	NW(LB)	REF.(CODE)	PTOS (PT)
4,0	8,8	30500048	78



Sombrilla exagonal Ø300cm. Sistema de apertura por polea abierta. Mástil en 48mm antracita. Cubierta en poliéster de 240g/m2 crudo. **Modelo reforzado. Alta resistencia a la intemperie.**



TM(cm)	PS(IN)	SA	OS
38,0	15,0	MANIVELA	CRANK
PN(kg)	NW(LB)	REF.(CODE)	PTOS (PT)
12,3	27,1	30500069	266

Base de resina para sombrilla de mástil central. Tubo adaptable a varios diámetros de mástil. Fijación por palomilla. Ø53x35cm. Meso 25Kgs. Ruedas de transporte con freno incorporado.



PN(kg)	NW(LB)	REF.(CODE)	PTOS (PT)
25,0	55,1	30500085	70



Sombrilla Rectangular 200X300cm. Sistema de apertura por manivela. Mástil divisible en 38mm color blanco. Cubierta en poliester de 160g/m2 color crudo.



TM(CM)	PS(IN)	SA	OS
38,0	15,0	MANIVELA	CRANK
PN(KG)	NW(LB)	REF.(CODE)	PTOS (PT)
4,5	9,9	30500051	96



Sombrilla Rectangular 200X300cm. Sistema de apertura por manivela. Mástil divisible en 38mm color gris antracita. Cubierta en poliester de 160g/m2 color amarillo.

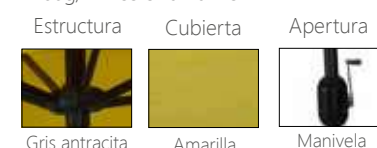

TM(CM)	PS(IN)	SA	OS
38,0	15,0	MANIVELA	CRANK
PN(KG)	NW(LB)	REF.(CODE)	PTOS (PT)
4,5	9,9	30500050	96



Sombrilla Rectangular 200X300cm. Sistema de apertura por manivela. Mástil divisible en 38mm color gris antracita. Cubierta en poliester de 160g/m2 color azul.

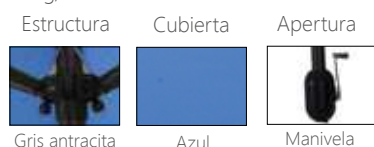

TM(CM)	PS(IN)	SA	OS
38,0	15,0	MANIVELA	CRANK
PN(KG)	NW(LB)	REF.(CODE)	PTOS (PT)
4,5	9,9	30500049	96



Sombrilla Rectangular 200X300cm. Sistema de apertura por manivela. Mástil divisible en 38mm color blanco. Cubierta en poliester de 160g/m2 color Blanco.



TM(CM)	PS(IN)	SA	OS
38,0	15,0	MANIVELA	CRANK
PN(KG)	NW(LB)	REF.(CODE)	PTOS (PT)
4,5	9,9	30500076	96



Sombrilla Rectangular 200X300cm. Sistema de apertura por manivela. Mástil divisible en 38mm color blanco. Cubierta en poliester de 160g/m2 color Granate.

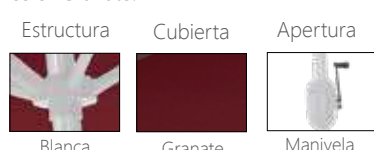

TM(CM)	PS(IN)	SA	OS
38,0	15,0	MANIVELA	CRANK
PN(KG)	NW(LB)	REF.(CODE)	PTOS (PT)
4,5	9,9	30500075	96



Sombrilla cuadrada 250x250cm. Sistema de apertura por polea abierta. Mástil en 48mm color blanco. Cubierta en poliester de 240g/m2 color blanco. Modelo reforzado. Alta resistencia a la intemperie.

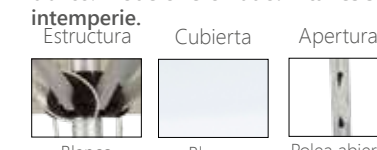

TM(CM)	PS(IN)	SA	OS
48,0	18,9	MANUAL	MANUAL
PN(KG)	NW(LB)	REF.(CODE)	PTOS (PT)
7,5	16,5	30500077	280



Base de sombrilla de Granito Redonda. Con asa de transporte y ruedas inferiores. Admite diferentes diámetros de mástil.

Peso 35Kg.



PN(KG)	NW(LB)	REF.(CODE)	PTOS (PT)
35,0	77,2	30500130	144



Base de sombrilla de Granito Cuadrada. Con asa de transporte extensible y ruedas traseras. Admite diferentes diámetros de mástil. **Peso 40Kg.**

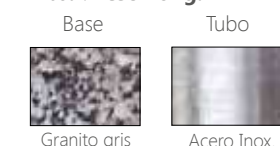

PN(KG)	NW(LB)	REF.(CODE)	PTOS (PT)
40,0	88,2	30500131	164

TM/PS: Tamaño mástil (Pole size)

SA/OS: Sistema apertura (Opening system)

PN/NW: Peso neto (Net weight)



Sombrilla octogonal súper luxe Ø350cm. Sistema de rotación 360°. Mástil reforzado DE 110X78mm en aluminio color gris antracita. Cubierta en poliéster de 240g/m2 color crudo.



TM(cm)	PS(IN)	SA	OS
110/78	43,3/30,8	MANIVELA	CRANK
PN(kg)	NW(Lb)	REF.(CODE)	PTOS (PT)
29,0	63,9	30500101	810

48cm
18.9"

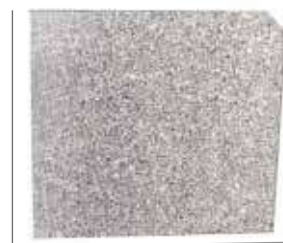

48cm
18.9"

5.5cm
2.2"

Loseta para sombrilla lateral Súper Luxe. Granito de alta calidad.

Peso 25Kg.

(Cantidad min. Recomendada 4 unidades)

Base



Granito gris

PN(kg)	NW(Lb)	REF.(CODE)	PTOS (PT)
25,0	55,1	30500132	38



Sombrilla rectangular súper luxe 400X300cm. Sistema de rotación 360°. Mástil reforzado DE 110X78mm en aluminio color gris antracita. Cubierta en poliéster de 240g/m2 color crudo.



TM(cm)	PS(IN)	SA	OS
110/78	43,3/30,8	MANIVELA	CRANK
PN(kg)	NW(Lb)	REF.(CODE)	PTOS (PT)
31,0	68,3	30500102	986



Base rellenable para sombrilla superluxe. Medida Ø100cm. Peso máximo de carga 125Kgs. Cubierta desmontable.

PN(kg)	NW(Lb)	REF.(CODE)	PTOS (PT)
9,0	19,8	30500078	186



Base rellenable para sombrilla superluxe. Medida Ø100cm. Peso máximo de carga 125Kgs. Cubierta desmontable. Incluye base con ruedas para transporte.

PN(kg)	NW(Lb)	REF.(CODE)	PTOS (PT)
23,0	50,7	30500079	344



Pérgola corredera modelo Luxe. Estructura de aluminio con pilares cuadrados de 90x90mm. Cubierta corredera en poliéster de 240g/m2. Medidas: 300x300cm



Crudo

TM(CM)	PS(IN)	SA	OS
90/90	35,4/35,4	DELIZANTE	SLIDING
PN(KG)	NW(LB)	REF.(CODE)	PTOS (PT)
	2	30500041	754



Gris antracita

PROTECCIÓN SILLAS / TABURETES



Cubierta 4-6 sillas apilable.
Cubierta Hidrofuga. Tejido Ripstop alta durabilidad con laminado transpirable. Doble costura interna. Tensores de ajuste en extremos para una mejor fijación. Color antracita.

REF.(CODE)	PTOS (PT)
30400100	34



Cubierta silla no apilable.
Cubierta Hidrofuga. Tejido Ripstop alta durabilidad con laminado transpirable. Doble costura interna. Tensores de ajuste en extremos para una mejor fijación. Color antracita.

REF.(CODE)	PTOS (PT)
30400440	30

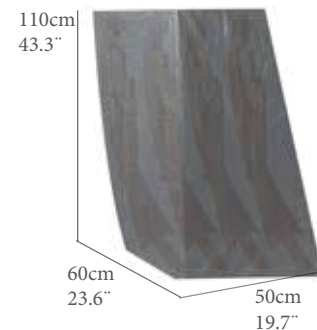

Cubierta para sillas plegables.
Cubierta Hidrofuga. Tejido Ripstop alta durabilidad con laminado transpirable. Doble costura interna. Tensores de ajuste en extremos para una mejor fijación. Color antracita.

REF.(CODE)	PTOS (PT)
3040442	30



Cubierta para taburete alto.
Cubierta Hidrofuga. Tejido Ripstop alta durabilidad con laminado transpirable. Doble costura interna. Tensores de ajuste en extremos para una mejor fijación. Color antracita.

REF.(CODE)	PTOS (PT)
30400441	34



PROTECCIÓN SILLÓN / SOFA



Cubierta sofa 1 plaza M
Cubierta Hidrofuga. Tejido Ripstop alta durabilidad con laminado transpirable. Doble costura interna. Tensores de ajuste en extremos para una mejor fijación. Color antracita.

REF.(CODE)	PTOS (PT)
30400443	36



Cubierta sofa 2 plazas M
Cubierta Hidrofuga. Tejido Ripstop alta durabilidad con laminado transpirable. Doble costura interna. Tensores de ajuste en extremos para una mejor fijación. Color antracita.

REF.(CODE)	PTOS (PT)
30400444	44



Cubierta sofa 3 plazas M
Cubierta Hidrofuga. Tejido Ripstop alta durabilidad con laminado transpirable. Doble costura interna. Tensores de ajuste en extremos para una mejor fijación. Color antracita.

REF.(CODE)	PTOS (PT)
30400446	54



Cubierta sofa 1 plaza L
Cubierta Hidrofuga. Tejido Ripstop alta durabilidad con laminado transpirable. Doble costura interna. Tensores de ajuste en extremos para una mejor fijación. Color antracita.

REF.(CODE)	PTOS (PT)
30400118	38



Cubierta sofa 2 plazas L
Cubierta Hidrofuga. Tejido Ripstop alta durabilidad con laminado transpirable. Doble costura interna. Tensores de ajuste en extremos para una mejor fijación. Color antracita.

REF.(CODE)	PTOS (PT)
30400445	48



Cubierta sofa 3 plazas L
Cubierta Hidrofuga. Tejido Ripstop alta durabilidad con laminado transpirable. Doble costura interna. Tensores de ajuste en extremos para una mejor fijación. Color antracita.

REF.(CODE)	PTOS (PT)
30400448	58

PROTECCIÓN MESA ALTA / BAR



Cubierta barra plegable
Cubierta Hidrofuga. Tejido Ripstop alta durabilidad con laminado transpirable. Doble costura interna. Tensores de ajuste en extremos para una mejor fijación. Color antracita.

REF.(CODE)	PTOS (PT)
30400468	38

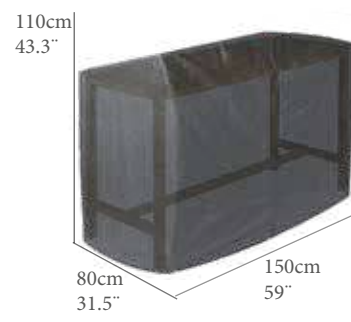

Cubierta mesa barra alta S
Cubierta Hidrofuga. Tejido Ripstop alta durabilidad con laminado transpirable. Doble costura interna. Tensores de ajuste en extremos para una mejor fijación. Color antracita.

REF.(CODE)	PTOS (PT)
30400461	52

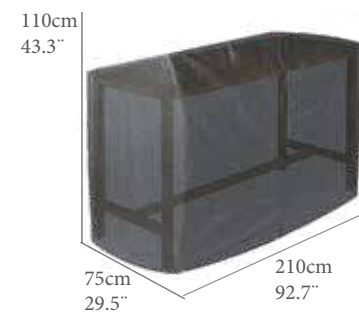

Cubierta mesa barra alta M
Cubierta Hidrofuga. Tejido Ripstop alta durabilidad con laminado transpirable. Doble costura interna. Tensores de ajuste en extremos para una mejor fijación. Color antracita.

REF.(CODE)	PTOS (PT)
30400466	56





Cubierta mesa rectangular.
Cubierta Hidrofuga. Tejido Ripstop alta durabilidad con laminado transpirable. Doble costura interna. Tensores de ajuste en extremos para una mejor fijación. Color antracita.

REF.(CODE)	PTOS (PT)
30400458	36



Cubierta mesa rectangular.
Cubierta Hidrofuga. Tejido Ripstop alta durabilidad con laminado transpirable. Doble costura interna. Tensores de ajuste en extremos para una mejor fijación. Color antracita.

REF.(CODE)	PTOS (PT)
30400108	44



Cubierta mesa rectangular.
Cubierta Hidrofuga. Tejido Ripstop alta durabilidad con laminado transpirable. Doble costura interna. Tensores de ajuste en extremos para una mejor fijación. Color antracita.

REF.(CODE)	PTOS (PT)
30400103	46



Cubierta mesa rectangular.
Cubierta Hidrofuga. Tejido Ripstop alta durabilidad con laminado transpirable. Doble costura interna. Tensores de ajuste en extremos para una mejor fijación. Color antracita.

REF.(CODE)	PTOS (PT)
30400104	48



Cubierta mesa rectangular.
Cubierta Hidrofuga. Tejido Ripstop alta durabilidad con laminado transpirable. Doble costura interna. Tensores de ajuste en extremos para una mejor fijación. Color antracita.

REF.(CODE)	PTOS (PT)
30400105	52



Cubierta mesa rectangular.
Cubierta Hidrofuga. Tejido Ripstop alta durabilidad con laminado transpirable. Doble costura interna. Tensores de ajuste en extremos para una mejor fijación. Color antracita.

REF.(CODE)	PTOS (PT)
30400106	54



Cubierta mesa rectangular.
Cubierta Hidrofuga. Tejido Ripstop alta durabilidad con laminado transpirable. Doble costura interna. Tensores de ajuste en extremos para una mejor fijación. Color antracita.

REF.(CODE)	PTOS (PT)
30400459	58



Cubierta mesa rectangular.
Cubierta Hidrofuga. Tejido Ripstop alta durabilidad con laminado transpirable. Doble costura interna. Tensores de ajuste en extremos para una mejor fijación. Color antracita.

REF.(CODE)	PTOS (PT)
30400107	60



Cubierta mesa rectangular.
Cubierta Hidrofuga. Tejido Ripstop alta durabilidad con laminado transpirable. Doble costura interna. Tensores de ajuste en extremos para una mejor fijación. Color antracita.

REF.(CODE)	PTOS (PT)
30400122	56

PROTECCIÓN MESAS DE COMEDOR CUADRADAS



Cubierta mesa cuadrada
Cubierta Hidrofuga. Tejido Ripstop alta durabilidad con laminado transpirable. Doble costura interna. Tensores de ajuste en extremos para una mejor fijación. Color antracita.

REF.(CODE)	PTOS (PT)
30400455	32



Cubierta mesa cuadrada
Cubierta Hidrofuga. Tejido Ripstop alta durabilidad con laminado transpirable. Doble costura interna. Tensores de ajuste en extremos para una mejor fijación. Color antracita.

REF.(CODE)	PTOS (PT)
30400456	34



Cubierta mesa cuadrada
Cubierta Hidrofuga. Tejido Ripstop alta durabilidad con laminado transpirable. Doble costura interna. Tensores de ajuste en extremos para una mejor fijación. Color antracita.

REF.(CODE)	PTOS (PT)
30400101	36



Cubierta mesa cuadrada
Cubierta Hidrofuga. Tejido Ripstop alta durabilidad con laminado transpirable. Doble costura interna. Tensores de ajuste en extremos para una mejor fijación. Color antracita.

REF.(CODE)	PTOS (PT)
30400102	38



PROTECCIÓN MESAS DE COMEDOR REDONDA



Cubierta mesa redonda.
Cubierta Hidrofuga. Tejido Ripstop alta durabilidad con laminado transpirable. Doble costura interna. Tensores de ajuste en extremos para una mejor fijación. Color antracita.

REF.(CODE)	PTOS (PT)
30400460	26



Cubierta mesa redonda.
Cubierta Hidrofuga. Tejido Ripstop alta durabilidad con laminado transpirable. Doble costura interna. Tensores de ajuste en extremos para una mejor fijación. Color antracita.

REF.(CODE)	PTOS (PT)
30400467	32



Cubierta mesa redonda.
Cubierta Hidrofuga. Tejido Ripstop alta durabilidad con laminado transpirable. Doble costura interna. Tensores de ajuste en extremos para una mejor fijación. Color antracita.

REF.(CODE)	PTOS (PT)
30400109	38



Cubierta mesa redonda.
Cubierta Hidrofuga. Tejido Ripstop alta durabilidad con laminado transpirable. Doble costura interna. Tensores de ajuste en extremos para una mejor fijación. Color antracita.

REF.(CODE)	PTOS (PT)
30400110	40



PROTECCIÓN MESA AUX.RECTANGULAR

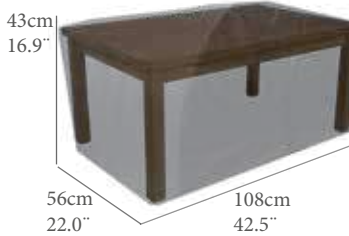

Cubierta mesa aux.rectang.S
Cubierta Hidrofuga. Tejido Ripstop alta durabilidad con laminado transpirable. Doble costura interna. Tensores de ajuste en extremos para una mejor fijación. Color antracita.

REF.(CODE)	PTOS (PT)
30400116	26

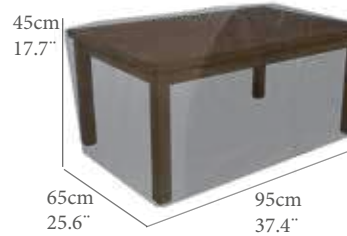

Cubierta mesa aux.rectang.M
Cubierta Hidrofuga. Tejido Ripstop alta durabilidad con laminado transpirable. Doble costura interna. Tensores de ajuste en extremos para una mejor fijación. Color antracita.

REF.(CODE)	PTOS (PT)
30400452	26



Cubierta mesa aux.rectang.L
Cubierta Hidrofuga. Tejido Ripstop alta durabilidad con laminado transpirable. Doble costura interna. Tensores de ajuste en extremos para una mejor fijación. Color antracita.

REF.(CODE)	PTOS (PT)
30400115	28

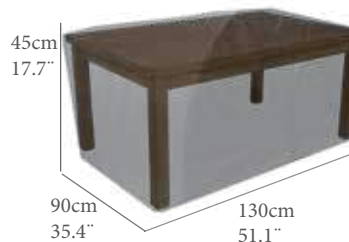

Cubierta mesa aux.rectang.XL
Cubierta Hidrofuga. Tejido Ripstop alta durabilidad con laminado transpirable. Doble costura interna. Tensores de ajuste en extremos para una mejor fijación. Color antracita.

REF.(CODE)	PTOS (PT)
30400451	32

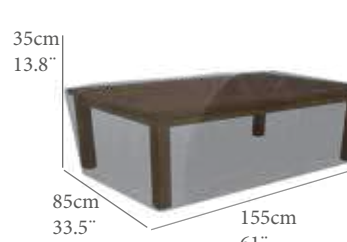

Cubierta mesa aux.rectang.Baja
Cubierta Hidrofuga. Tejido Ripstop alta durabilidad con laminado transpirable. Doble costura interna. Tensores de ajuste en extremos para una mejor fijación. Color antracita.

REF.(CODE)	PTOS (PT)
30400464	32

PROTECCIÓN MESA AUX.CUADRADA

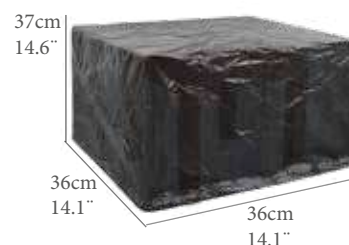

Cubierta mesa aux.cuadrada.S
Cubierta Hidrofuga. Tejido Ripstop alta durabilidad con laminado transpirable. Doble costura interna. Tensores de ajuste en extremos para una mejor fijación. Color antracita.

REF.(CODE)	PTOS (PT)
30400454	18

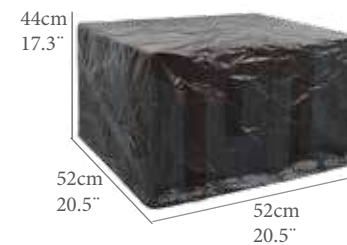

Cubierta mesa aux.cuadrada.M
Cubierta Hidrofuga. Tejido Ripstop alta durabilidad con laminado transpirable. Doble costura interna. Tensores de ajuste en extremos para una mejor fijación. Color antracita.

REF.(CODE)	PTOS (PT)
30400114	22



Cubierta mesa aux.cuadrada.L
Cubierta Hidrofuga. Tejido Ripstop alta durabilidad con laminado transpirable. Doble costura interna. Tensores de ajuste en extremos para una mejor fijación. Color antracita.

REF.(CODE)	PTOS (PT)
30400463	26





Cubierta mesa aux.redonda S
Cubierta Hidrofuga. Tejido Ripstop alta durabilidad con laminado transpirable. Doble costura interna. Tensores de ajuste en extremos para una mejor fijación. Color antracita.

REF.(CODE)	PTOS (PT)
30400453	32



Cubierta mesa aux.redonda L
Cubierta Hidrofuga. Tejido Ripstop alta durabilidad con laminado transpirable. Doble costura interna. Tensores de ajuste en extremos para una mejor fijación. Color antracita.

REF.(CODE)	PTOS (PT)
30400465	34

PROTECCIÓN TUMBONAS



Cubierta mini tumbona
Cubierta Hidrofuga. Tejido Ripstop alta durabilidad con laminado transpirable. Doble costura interna. Tensores de ajuste en extremos para una mejor fijación. Color antracita.

REF.(CODE)	PTOS (PT)
30400450	32



Cubierta tumbona apilable S
Cubierta Hidrofuga. Tejido Ripstop alta durabilidad con laminado transpirable. Doble costura interna. Tensores de ajuste en extremos para una mejor fijación. Color antracita.

REF.(CODE)	PTOS (PT)
30400449	42



Cubierta tumbona apilable M
Cubierta Hidrofuga. Tejido Ripstop alta durabilidad con laminado transpirable. Doble costura interna. Tensores de ajuste en extremos para una mejor fijación. Color antracita.

REF.(CODE)	PTOS (PT)
30400112	44



Cubierta tumbona apilable L
Cubierta Hidrofuga. Tejido Ripstop alta durabilidad con laminado transpirable. Doble costura interna. Tensores de ajuste en extremos para una mejor fijación. Color antracita.

REF.(CODE)	PTOS (PT)
30400113	46

PROTECCIÓN DAYBED

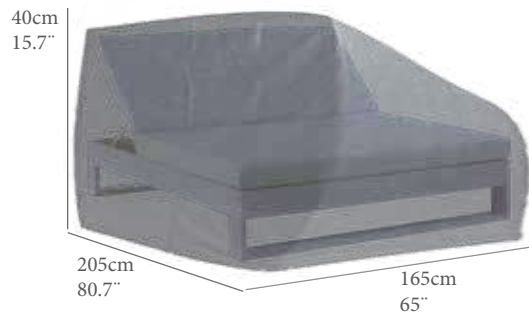

Cubierta para daybed.
Cubierta Hidrofuga. Tejido Ripstop alta durabilidad con laminado transpirable. Doble costura interna. Tensores de ajuste en extremos para una mejor fijación. Color antracita.

REF.(CODE)	PTOS (PT)
30400462	50

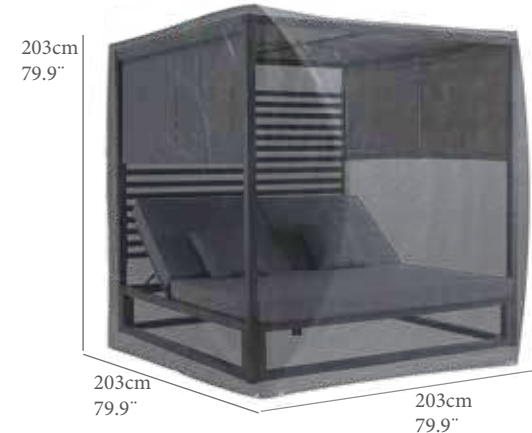

Cubierta para daybed con dosel
Cubierta Hidrofuga. Tejido Ripstop alta durabilidad con laminado transpirable. Doble costura interna. Tensores de ajuste en extremos para una mejor fijación. Color antracita.

REF.(CODE)	PTOS (PT)
30400111	118



Cubierta para daybed redondo M
Cubierta Hidrofuga. Tejido Ripstop alta durabilidad con laminado transpirable. Doble costura interna. Tensores de ajuste en extremos para una mejor fijación. Color antracita.

REF.(CODE)	PTOS (PT)
30400121	56



Cubierta para daybed redondo L
Cubierta Hidrofuga. Tejido Ripstop alta durabilidad con laminado transpirable. Doble costura interna. Tensores de ajuste en extremos para una mejor fijación. Color antracita.

REF.(CODE)	PTOS (PT)
30400120	68



PROTECCIÓN CONJUNTOS.

90cm
35.4"



Ø160cm
63"

Cubierta para set redondo M
Cubierta Hidrofuga. Tejido
Ripstop alta durabilidad con
laminado transpirable. Doble
costura interna. Tensores de
ajuste en extremos para una
mejor fijación. Color antracita.

REF.(CODE)	PTOS (PT)
30400469	52

90cm
35.4"



Ø200cm
78.7"

Cubierta para set redondo L
Cubierta Hidrofuga. Tejido
Ripstop alta durabilidad con
laminado transpirable. Doble
costura interna. Tensores de
ajuste en extremos para una
mejor fijación. Color antracita.

REF.(CODE)	PTOS (PT)
30400470	66

90cm
35.4"



160cm
63"

160cm
63"

Cubierta para set cuadrado M
Cubierta Hidrofuga. Tejido
Ripstop alta durabilidad con
laminado transpirable. Doble
costura interna. Tensores de
ajuste en extremos para una
mejor fijación. Color antracita.

REF.(CODE)	PTOS (PT)
30400471	60

90cm
35.4"



300cm
118"

300cm
118"

Cubierta para set cuadrado L
Cubierta Hidrofuga. Tejido
Ripstop alta durabilidad con
laminado transpirable. Doble
costura interna. Tensores de
ajuste en extremos para una
mejor fijación. Color antracita.

REF.(CODE)	PTOS (PT)
30400472	116

90cm
35.4"



160cm
63"

260cm
102.4"

Cubierta set rectangular M
Cubierta Hidrofuga. Tejido
Ripstop alta durabilidad con
laminado transpirable. Doble
costura interna. Tensores de
ajuste en extremos para una
mejor fijación. Color antracita.

REF.(CODE)	PTOS (PT)
30400473	76

90cm
35.4"



200cm
78.7"

300cm
118"

Cubierta set rectangular L
Cubierta Hidrofuga. Tejido
Ripstop alta durabilidad con
laminado transpirable. Doble
costura interna. Tensores de
ajuste en extremos para una
mejor fijación. Color antracita.

REF.(CODE)	PTOS (PT)
30400474	100

PROTECCIÓN AUXILIAR.

200cm
78.7"



Ø120cm
47.2"

Cubierta para balancin
Cubierta Hidrofuga. Tejido
Ripstop alta durabilidad con
laminado transpirable. Doble
costura interna. Tensores de
ajuste en extremos para una
mejor fijación. Color antracita.

REF.(CODE)	PTOS (PT)
30400477	60

190cm
74.8"



30cm / 50cm
11.8" / 19.7"

Cubierta para sombrilla
Cubierta Hidrofuga. Tejido
Ripstop alta durabilidad con
laminado transpirable. Doble
costura interna. Tensores de
ajuste en extremos para una
mejor fijación. Color antracita.

REF.(CODE)	PTOS (PT)
30400475	28

varilla para colocacion incluida

256cm
100.8"



50cm / 75cm
19.7" / 29.5"

Cubierta para sombrilla lateral
Cubierta Hidrofuga. Tejido
Ripstop alta durabilidad con
laminado transpirable. Doble
costura interna. Tensores de
ajuste en extremos para una
mejor fijación. Color antracita.

REF.(CODE)	PTOS (PT)
30400476	38

varilla para colocacion incluida





TECNICO



Silla de comedor con brazos Apolo. Estructura en aluminio color antracita y textilene color gris medio..Brazos en polywood color teca. Alta resistencia a la intemperie. Apilable.

Aluminio	Textilene	Polywood			
Antracita SVAL4	Gris medio SVTX6	Teca SVPW02			
AA(cm)	SH(IN)	AB(cm)	AH(IN)	AE(cm)	FH(IN)
45	17.7	63	24.8	88	34.6
PN(kg)	NW(LB)	REF.(CODE)	PTOS (PT)		
3.6	7.9	30200864	252		



Silla de comedor con brazos Apolo. Estructura en aluminio color blanco y textilene color gris medio..Brazos en polywood color teca. Alta resistencia a la intemperie. Apilable.

Aluminio	Textilene	Polywood			
Blanco SVAL1	Gris medio SVTX6	Teca SVPW02			
AA(cm)	SH(IN)	AB(cm)	AH(IN)	AE(cm)	FH(IN)
45	17.7	63	24.8	88	34.6
PN(kg)	NW(LB)	REF.(CODE)	PTOS (PT)		
3.6	7.9	30200853	252		



Sillón director con brazos Apolo. Estructura en aluminio color antracita y textilene color gris medio..Brazos en polywood color teca. Alta resistencia a la intemperie. Plegable

Aluminio	Textilene	Polywood			
Antracita SVAL4	Gris medio SVTX6	Teca SVPW02			
AA(cm)	SH(IN)	AB(cm)	AH(IN)	AE(cm)	FH(IN)
45	17.7	63	24.8	88	34.6
PN(kg)	NW(LB)	REF.(CODE)	PTOS (PT)		
4.4	7.7	30200865	312		



Sillón director con brazos Apolo. Estructura en aluminio color blanco y textilene color gris medio..Brazos en polywood color teca. Alta resistencia a la intemperie. Plegable

Aluminio	Textilene	Polywood			
Blanco SVAL1	Gris medio SVTX6	Teca SVPW02			
AA(cm)	SH(IN)	AB(cm)	AH(IN)	AE(cm)	FH(IN)
45	17.7	63	24.8	88	34.6
PN(kg)	NW(LB)	REF.(CODE)	PTOS (PT)		
4.4	7.7	30200854	312		



Sillón balancín con brazos Apolo. Estructura en aluminio color antracita y textilene color gris medio..Brazos en polywood color teca. Alta resistencia a la intemperie.

Aluminio	Textilene	Polywood			
Antracita SVAL4	Gris medio SVTX6	Teca SVPW02			
AA(cm)	SH(IN)	AB(cm)	AH(IN)	AE(cm)	FH(IN)
34/37	13.4/14.5	57	22.4	92	36.2
PN(kg)	NW(LB)	REF.(CODE)	PTOS (PT)		
5,2	11,4	30200871	358		



Sillón balancín con brazos Apolo. Estructura en aluminio color blanco y textilene color gris medio..Brazos en polywood color teca. Alta resistencia a la intemperie.

Aluminio	Textilene	Polywood			
Blanco SVAL1	Gris medio SVTX6	Teca SVPW02			
AA(cm)	SH(IN)	AB(cm)	AH(IN)	AE(cm)	FH(IN)
34/37	13.4/14.5	57	22.4	92	36.2
PN(kg)	NW(LB)	REF.(CODE)	PTOS (PT)		
5,2	11,4	30200860	358		

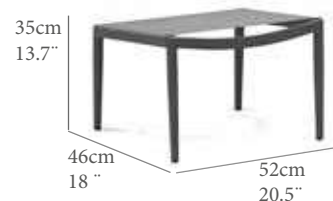

Reposapiés Apolo. Estructura en aluminio color antracita y textilene color gris medio.. Alta resistencia a la intemperie. Apilable.

Aluminio	Textilene				
Antracita SVAL4	Gris medio SVTX6				
AA(cm)	SH(IN)	AB(cm)	AH(IN)	AE(cm)	FH(IN)
32	12.6	32	12.6		
PN(kg)	NW(LB)	REF.(CODE)	PTOS (PT)		
1,8	4	30200870	126		

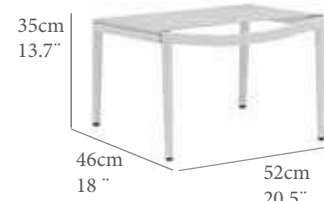

Reposapiés Apolo. Estructura en aluminio color blanco y textilene color gris medio.. Alta resistencia a la intemperie. Apilable.

Aluminio	Textilene				
Blanco SVAL1	Gris medio SVTX6				
AA(cm)	SH(IN)	AB(cm)	AH(IN)	AE(cm)	FH(IN)
32	12.6	32	12.6		
PN(kg)	NW(LB)	REF.(CODE)	PTOS (PT)		
1,8	4	30200859	126		



Sillón 1 plaza con brazos Apolo. Estructura en aluminio color antracita y textilene color gris medio. Brazos en polywood color teca. Alta resistencia a la intemperie. Apilable.

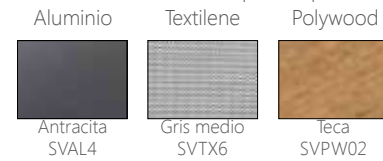

AA(cm)	SH(IN)	AB(cm)	AH(IN)	AE(cm)	FH(IN)
41	16.1	58	22.8	79	31.1
PN(kg)	NW(LB)	REF.(CODE)		PTOS (PT)	
4.4	7.7	30200868		302	



Sillón 1 plaza con brazos Apolo. Estructura en aluminio color blanco y textilene color gris medio. Brazos en polywood color teca. Alta resistencia a la intemperie. Apilable.

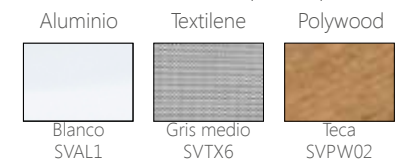

AA(cm)	SH(IN)	AB(cm)	AH(IN)	AE(cm)	FH(IN)
41	16.1	58	22.8	79	31.1
PN(kg)	NW(LB)	REF.(CODE)		PTOS (PT)	
4.4	7.7	30200857		302	



Sofá 2 plazas con brazos Apolo. Estructura en aluminio color antracita y textilene color gris medio. Brazos en polywood color teca. Alta resistencia a la intemperie. Apilable.

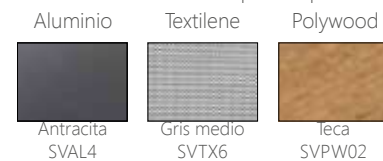

AA(cm)	SH(IN)	AB(cm)	AH(IN)	AE(cm)	FH(IN)
41	16.1	58	22.8	79	31.1
PN(kg)	NW(LB)	REF.(CODE)		PTOS (PT)	
6.6	14.5	30200869		488	



Sofá 2 plazas con brazos Apolo. Estructura en aluminio color blanco y textilene color gris medio. Brazos en polywood color teca. Alta resistencia a la intemperie. Apilable.



AA(cm)	SH(IN)	AB(cm)	AH(IN)	AE(cm)	FH(IN)
41	16.1	58	22.8	79	31.1
PN(kg)	NW(LB)	REF.(CODE)		PTOS (PT)	
6.6	14.5	30200858		488	



Mesa Auxiliar cuadrada modelo Apolo. Estructura en aluminio color antracita. Encimera en cristal cerámico de 8mm. Alta resistencia a la intemperie. Requiere montaje.



GT(cm)	TT(IN)	AL(cm)	FH(IN)	
8.0	3.14	39	15.3	
PN(kg)	NW(LB)	REF.(CODE)		PTOS (PT)
6	13.2	30200867		160



Mesa Auxiliar cuadrada modelo Apolo. Estructura en aluminio color blanco. Encimera en cristal cerámico de 8mm. Alta resistencia a la intemperie. Requiere montaje.



GT(cm)	TT(IN)	AL(cm)	FH(IN)	
8.0	3.14	39	15.3	
PN(kg)	NW(LB)	REF.(CODE)		PTOS (PT)
6	13.2	30200856		160



Mesa Auxiliar rectangular modelo Apolo. Estructura en aluminio color antracita. Encimera en cristal cerámico de 8mm. Alta resistencia a la intemperie. Requiere montaje.



GT(cm)	TT(IN)	AL(cm)	FH(IN)	
8.0	3.14	39	15.3	
PN(kg)	NW(LB)	REF.(CODE)		PTOS (PT)
11	24.2	30200866		236



Mesa Auxiliar rectangular modelo Apolo. Estructura en aluminio color blanco. Encimera en cristal cerámico de 8mm. Alta resistencia a la intemperie. Requiere montaje.



GT(cm)	TT(IN)	AL(cm)	FH(IN)	
8.0	3.14	39	15.3	
PN(kg)	NW(LB)	REF.(CODE)		PTOS (PT)
11	24.2	30200855		236

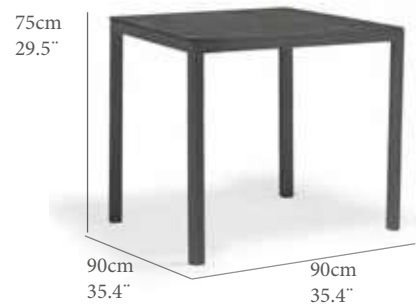

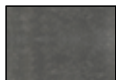

Mesa de comedor Apolo. Estructura en aluminio color antracita. Encimera en cristal cerámico de 8mm. Alta resistencia a la intemperie. Requiere montaje.

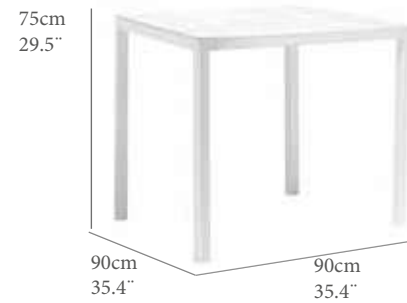
Aluminio		Cristal	
			
Antracita SVAL4	Gris cerámico SVCT11		
GT(cm)	TT(IN)	AL(cm)	FH(IN)
8.0	3.14	69.0	27.2
PN(kg)	NW(LB)	REF.(CODE)	PTOS (PT)
22	48.5	30200862	422



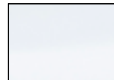

Mesa de comedor Apolo. Estructura en aluminio color blanco. Encimera en cristal cerámico de 8mm. Alta resistencia a la intemperie. Requiere montaje.

Aluminio		Cristal	
			
Blanco SVAL1	Ceram.Blanco SVCT14		
GT(cm)	TT(IN)	AL(cm)	FH(IN)
8.0	3.14	69.0	27.2
PN(kg)	NW(LB)	REF.(CODE)	PTOS (PT)
22	48.5	30500851	422



Mesa de comedor Apolo. Estructura en aluminio color antracita. Encimera en cristal cerámico de 8mm. Alta resistencia a la intemperie. Requiere montaje.

Aluminio		Cristal	
			
Antracita SVAL4	Gris cerámico SVCT11		
GT(cm)	TT(IN)	AL(cm)	FH(IN)
8.0	3.14	69.0	27.2
PN(kg)	NW(LB)	REF.(CODE)	PTOS (PT)
39.8	87.7	30200863	756

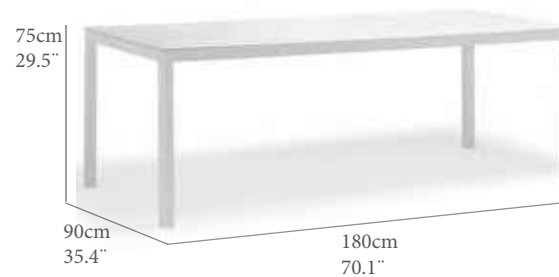

Mesa de comedor Apolo. Estructura en aluminio color blanco. Encimera en cristal cerámico de 3mm. Alta resistencia a la intemperie. Requiere montaje.

Aluminio		Cristal	
			
Blanco SVAL1	Ceram.Blanco SVCT14		
GT(cm)	TT(IN)	AL(cm)	FH(IN)
8.0	3.14	69.0	27.2
PN(kg)	NW(LB)	REF.(CODE)	PTOS (PT)
39.8	87.7	30200852	756

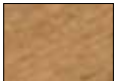

Mesa rectangular extensible Apolo. Estructura en aluminio color antracita. Encimera en cristal cerámico de 8mm. Extensible en HPL. Alta resistencia a la intemperie. Requiere montaje.

Aluminio		Cristal		HPL	
					
Antracita SVAL4	Gris cerámico SVCT11	leca SVPW02			
GT(cm)	TT(IN)	AL(cm)	FH(IN)		
8.0	3.14	68	26.8		
PN(kg)	NW(LB)	REF.(CODE)	PTOS (PT)		
80	176.4	30200861	2214		



Mesa rectangular extensible Apolo. Estructura en aluminio color blanco. Encimera en cristal cerámico de 8mm. Extensible en HPL. Alta resistencia a la intemperie. Requiere montaje.

Aluminio		Cristal		HPL	
					
Blanco SVAL1	Ceram.Blanco SVCT14	leca SVPW02			
GT(cm)	TT(IN)	AL(cm)	FH(IN)		
8.0	3.14	68	26.8		
PN(kg)	NW(LB)	REF.(CODE)	PTOS (PT)		
80	176.4	30200850	2214		





Sofa 3 plazas Omi. Estructura en aluminio color antracita. Cojineria color Gris Tempo. **Con disposicion de plazas ajustable.** Madera de teca. Alta resistencia a la intemperie. Requiere montaje.

Aluminio		Textil		Madera	
Antracita SVAL4		Gris Tempo SVTX9		Teca SVTK01	
AA(cm)	SH(IN)	AB(cm)	AH(IN)	AE(cm)	FH(IN)
37	14.6			71	27.9
PN(kg)	NW(LB)	REF.(CODE)		PTOS (PT)	
40	88	30200797		1360	



Sofa 3 plazas Omi. Estructura en aluminio color blanco. Cojineria color Gris Tempo. **Con disposicion de plazas ajustable.** Madera de teca. Alta resistencia a la intemperie. Requiere montaje.

Aluminio		Textil		Madera	
Blanco SVAL1		Gris Tempo SVTX9		Teca SVTK01	
AA(cm)	SH(IN)	AB(cm)	AH(IN)	AE(cm)	FH(IN)
37	14.6			71	27.9
PN(kg)	NW(LB)	REF.(CODE)		PTOS (PT)	
40	88	30200792		1360	



Sofa esquinero Omi. Estructura en aluminio color antracita. Cojineria color Gris Tempo. **Con disposicion de plazas ajustable.** Madera de teca. Alta resistencia a la intemperie. Requiere montaje.

Aluminio		Textil		Madera	
Antracita SVAL4		Gris Tempo SVTX9		Teca SVTK01	
AA(cm)	SH(IN)	AB(cm)	AH(IN)	AE(cm)	FH(IN)
37	14.6			71	27.9
PN(kg)	NW(LB)	REF.(CODE)		PTOS (PT)	
40	88	30200798		1360	



Sofa esquinero Omi. Estructura en aluminio color blanco. Cojineria color Gris Tempo. **Con disposicion de plazas ajustable.** Madera de teca. Alta resistencia a la intemperie. Requiere montaje.

Aluminio		Textil		Madera	
Blanco SVAL1		Gris Tempo SVTX9		Teca SVTK01	
AA(cm)	SH(IN)	AB(cm)	AH(IN)	AE(cm)	FH(IN)
37	14.6			71	27.9
PN(kg)	NW(LB)	REF.(CODE)		PTOS (PT)	
40	88	30200793		1360	



Mesa de centro Omi. Estructura en aluminio color antracita. Encimera en madera de teca. Mesa movil superior color antracita. Alta resistencia a la intemperie.

Aluminio		Madera	
Antracita SVAL4		Teca SVTK01	
GT(cm)	TT(IN)	AL(cm)	FH(IN)
2	0.7	18	7
PN(kg)	NW(LB)	REF.(CODE)	
22	48.4	30200786	
		PTOS (PT)	
		510	



Mesa de centro Omi. Estructura en aluminio color blanco. Encimera en madera de teca. Mesa movil superior color blanco. Alta resistencia a la intemperie.

Aluminio		Madera	
Blanco SVAL1		Teca SVTK01	
GT(cm)	TT(IN)	AL(cm)	FH(IN)
2	0.7	18	7
PN(kg)	NW(LB)	REF.(CODE)	
22	48.4	30200781	
		PTOS (PT)	
		510	



Set rinconera Omi 3 piezas. Estructura en aluminio color antracita. Cojineria color Gris Tempo. Madera de teca. Alta resistencia a la intemperie. Requiere montaje.

PN(kg)	NW(LB)	REF.(CODE)		PTOS (PT)	
102	224.4	30200785		3172	



Set rinconera Omi 3 piezas. Estructura en aluminio color blanco. Cojineria color Gris Tempo. Madera de teca. Alta resistencia a la intemperie. Requiere montaje.

PN(kg)	NW(LB)	REF.(CODE)		PTOS (PT)	
102	224.4	30200780		3172	



Silla con brazos modelo Concept. Aluminio color blanco y textilene color blanco puro. Apilable y de gran resistencia a la intemperie.



AA(cm)	SH(IN)	AB(cm)	AH(IN)	AE(cm)	FH(IN)
46,0	18,1	65,6	25,8	86,0	33,9
PN(kg)	NW(LB)	REF.(CODE)	PTOS (PT)		
3,3	7,3	30200309	118		



Silla con brazos modelo Concept. Aluminio color blanco y textilene color Gris claro. Apilable y de gran resistencia a la intemperie.



AA(cm)	SH(IN)	AB(cm)	AH(IN)	AE(cm)	FH(IN)
46,0	18,1	65,6	25,8	86,0	33,9
PN(kg)	NW(LB)	REF.(CODE)	PTOS (PT)		
3,3	7,3	30200360	118		



Silla con brazos modelo Concept. Aluminio color blanco y textilene color Taupe. Apilable y de gran resistencia a la intemperie.



AA(cm)	SH(IN)	AB(cm)	AH(IN)	AE(cm)	FH(IN)
46,0	18,1	65,6	25,8	86,0	33,9
PN(kg)	NW(LB)	REF.(CODE)	PTOS (PT)		
3,3	7,3	30200301	118		

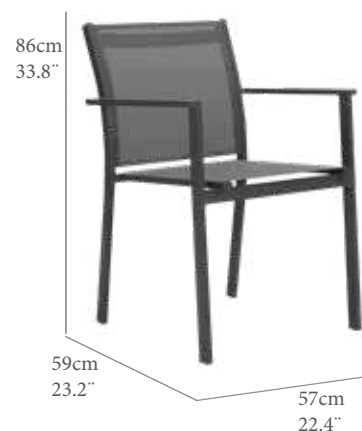

Silla con brazos modelo Concept. Aluminio color Antracita y textilene color Antracita Apilable y de gran resistencia a la intemperie.

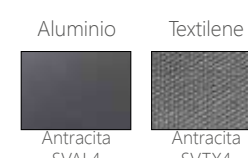

AA(cm)	SH(IN)	AB(cm)	AH(IN)	AE(cm)	FH(IN)
46,0	18,1	65,6	25,8	86,0	33,9
PN(kg)	NW(LB)	REF.(CODE)	PTOS (PT)		
3,3	7,3	30200291	118		



Silla con brazos modelo Curve. Aluminio color blanco y textilene color blanco. Detalle brazos color blanco. Apilable y de gran resistencia a la intemperie.



AA(cm)	SH(IN)	AB(cm)	AH(IN)	AE(cm)	FH(IN)
46,0	18,1	67,0	26,4	84,0	33,1
PN(kg)	NW(LB)	REF.(CODE)	PTOS (PT)		
3,1	6,8	30200310	142		



Silla con brazos modelo Curve. Aluminio color blanco y textilene color gris claro. Detalle brazos color gris claro. Apilable y de gran resistencia a la intemperie.



AA(cm)	SH(IN)	AB(cm)	AH(IN)	AE(cm)	FH(IN)
46,0	18,1	67,0	26,4	84,0	33,1
PN(kg)	NW(LB)	REF.(CODE)	PTOS (PT)		
3,1	6,8	30200357	142		



Silla con brazos modelo Curve. Aluminio color blanco y textilene color Taupe. Detalle brazos color Taupe. Apilable y de gran resistencia a la intemperie.



AA(cm)	SH(IN)	AB(cm)	AH(IN)	AE(cm)	FH(IN)
46,0	18,1	67,0	26,4	84,0	33,1
PN(kg)	NW(LB)	REF.(CODE)	PTOS (PT)		
3,1	6,8	30200302	142		



Silla con brazos modelo Curve. Aluminio color antracita y textilene color antracita. Detalle brazos color antracita. Apilable y de gran resistencia a la intemperie.

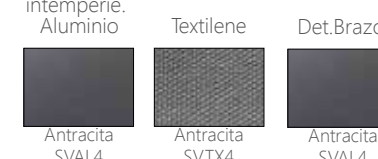

AA(cm)	SH(IN)	AB(cm)	AH(IN)	AE(cm)	FH(IN)
46,0	18,1	67,0	26,4	84,0	33,1
PN(kg)	NW(LB)	REF.(CODE)	PTOS (PT)		
3,1	6,8	30200292	142		



Sillón Multiposición modelo Concept. Aluminio color blanco y textilene color blanco. Respaldo regulable en 5 posiciones. Plegable y de gran resistencia a la intemperie.

Aluminio Textilene



AA(cm)	SH(IN)	AR(cm)	BH(IN)	AB(cm)	AA(IN)
47,5	18,7	98-113	38,6/44,5	74,0	29,1
PN(kg)	NW(LB)	REF.(CODE)	PTOS (PT)		
5,5	12,1	30200268	212		



Sillón Multiposición modelo Concept. Aluminio color blanco y textilene color gris claro. Respaldo regulable en 5 posiciones. Plegable y de gran resistencia a la intemperie.

Aluminio Textilene



AA(cm)	SH(IN)	AR(cm)	BH(IN)	AB(cm)	AA(IN)
47,5	18,7	98-113	38,6/44,5	74,0	29,1
PN(kg)	NW(LB)	REF.(CODE)	PTOS (PT)		
5,5	12,1	30200271	212		



Sillón Multiposición modelo Concept. Aluminio color blanco y textilene color taupe. Respaldo regulable en 5 posiciones. Plegable y de gran resistencia a la intemperie.

Aluminio Textilene



AA(cm)	SH(IN)	AR(cm)	BH(IN)	AB(cm)	AA(IN)
47,5	18,7	98-113	38,6/44,5	74,0	29,1
PN(kg)	NW(LB)	REF.(CODE)	PTOS (PT)		
5,5	12,1	30200269	212		



Sillón Multiposición modelo Concept. Aluminio color antracita y textilene color antracita. Respaldo regulable en 5 posiciones. Plegable y de gran resistencia a la intemperie.

Aluminio Textilene



AA(cm)	SH(IN)	AB(cm)	AH(IN)	AE(cm)	FH(IN)
47,5	18,7	74,0	29,1	98/113	38,6/44,5
PN(kg)	NW(LB)	REF.(CODE)	PTOS (PT)		
5,5	12,1	30200413	212		



Tumbona plegable modelo Boston. Aluminio color blanco y textilene color blanco puro. Respaldo regulable multiposicion.



AA(CM)	SH(IN)	AR(CM)	BH(IN)	AB(CM)	AA(IN)
32-39,5	12,6-15,5	63/81	24,8/31,9		
PN(KG)	NW(LB)	REF.(CODE)	PTOS (PT)		
5,9	13,0	30200312	240		



Tumbona plegable modelo Boston. Aluminio color blanco y textilene color Gris claro. Respaldo regulable multiposicion.



AA(CM)	SH(IN)	AR(CM)	BH(IN)	AB(CM)	AA(IN)
32-39,5	12,6-15,5	63/81	24,8/31,9		
PN(KG)	NW(LB)	REF.(CODE)	PTOS (PT)		
5,9	13,0	30200385	240		



Tumbona plegable modelo Boston. Aluminio color blanco y textilene color Taupe. Respaldo regulable multiposicion.



AA(CM)	SH(IN)	AR(CM)	BH(IN)	AB(CM)	AA(IN)
32-39,5	12,6-15,5	63/81	24,8/31,9		
PN(KG)	NW(LB)	REF.(CODE)	PTOS (PT)		
5,9	13,0	30200311	240		



Tumbona plegable modelo Boston. Aluminio color Taupe y textilene color Taupe. Respaldo regulable multiposicion.



AA(CM)	SH(IN)	AR(CM)	BH(IN)	AB(CM)	AA(IN)
32-39,5	12,6-15,5	63/81	24,8/31,9		
PN(KG)	NW(LB)	REF.(CODE)	PTOS (PT)		
5,9	13,0	30200387	240		



Tumbona plegable modelo Boston. Aluminio color gris Antracita y textilene color gris Antracita. Respaldo regulable multiposicion.

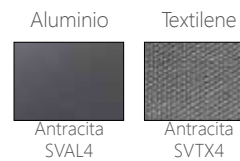

AA(CM)	SH(IN)	AR(CM)	BH(IN)	AB(CM)	AA(IN)
32-39,5	12,6-15,5	63/81	24,8/31,9		
PN(KG)	NW(LB)	REF.(CODE)	PTOS (PT)		
5,9	13,0	30200388	240		



Tumbona modelo Atena. Estructura de Aluminio color blanco y textilene color blanco. Respaldo regulable en 5 posiciones. Apilable.

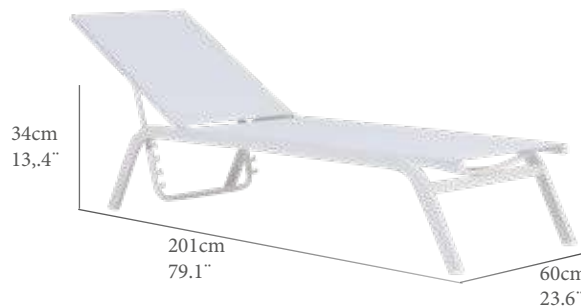

Aluminio		Textilene							
Blanco SVAL1		Blanco SVTX1		AA(cm)	SH(IN)	AR(cm)	BH(IN)	AB(cm)	AA(IN)
34,0	13,4	34/101	13,4/39,8						
PN(kg)	NW(LB)	REF.(CODE)	PTOS (PT)						
6,7	14,8	30200377	220						

Tumbona modelo Atena. Estructura de Aluminio color blanco y textilene color gris claro. Respaldo regulable en 5 posiciones. Apilable.

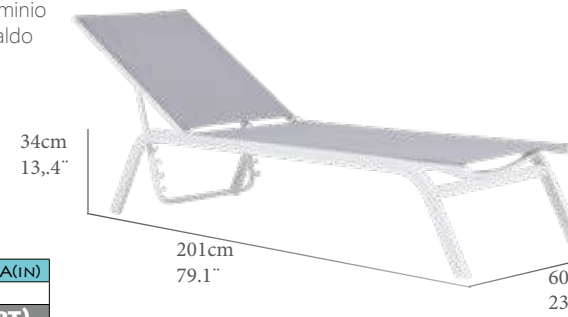

Aluminio		Textilene							
Blanco SVAL1		Gris claro SVTX2		AA(cm)	SH(IN)	AR(cm)	BH(IN)	AB(cm)	AA(IN)
34,0	13,4	34/101	13,4/39,8						
PN(kg)	NW(LB)	REF.(CODE)	PTOS (PT)						
6,7	14,8	30200380	220						

Tumbona modelo Atena. Estructura de Aluminio color blanco y textilene color taupe. Respaldo regulable en 5 posiciones. Apilable.

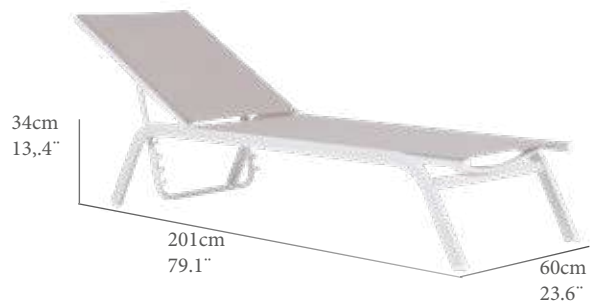

Aluminio		Textilene							
Blanco SVAL1		taupe SVTX5		AA(cm)	SH(IN)	AR(cm)	BH(IN)	AB(cm)	AA(IN)
34,0	13,4	34/101	13,4/39,8						
PN(kg)	NW(LB)	REF.(CODE)	PTOS (PT)						
6,7	14,8	30200378	220						

Tumbona modelo Atena. Estructura de Aluminio color taupe y textilene color taupe. Respaldo regulable en 5 posiciones. Apilable.

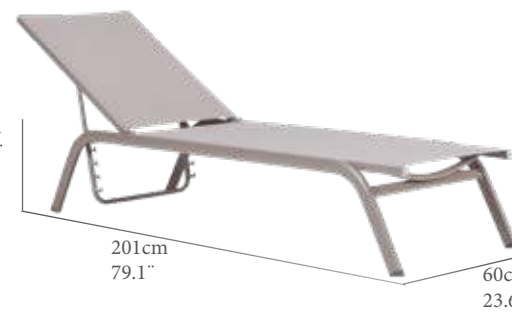

Aluminio		Textilene							
taupe SVAL3		taupe SVTX5		AA(cm)	SH(IN)	AR(cm)	BH(IN)	AB(cm)	AA(IN)
34,0	13,4	34/101	13,4/39,8						
PN(kg)	NW(LB)	REF.(CODE)	PTOS (PT)						
6,7	14,8	30200382	220						

Tumbona modelo Atena. Estructura de Aluminio color gris antracita y textilene color gris antracita. Respaldo regulable en 5 posiciones. Apilable.



Aluminio		Textilene							
Antracita SVAL4		Antracita SVTX4		AA(cm)	SH(IN)	AR(cm)	BH(IN)	AB(cm)	AA(IN)
34,0	13,4	34/101	13,4/39,8						
PN(kg)	NW(LB)	REF.(CODE)	PTOS (PT)						
6,7	14,8	30200383	220						



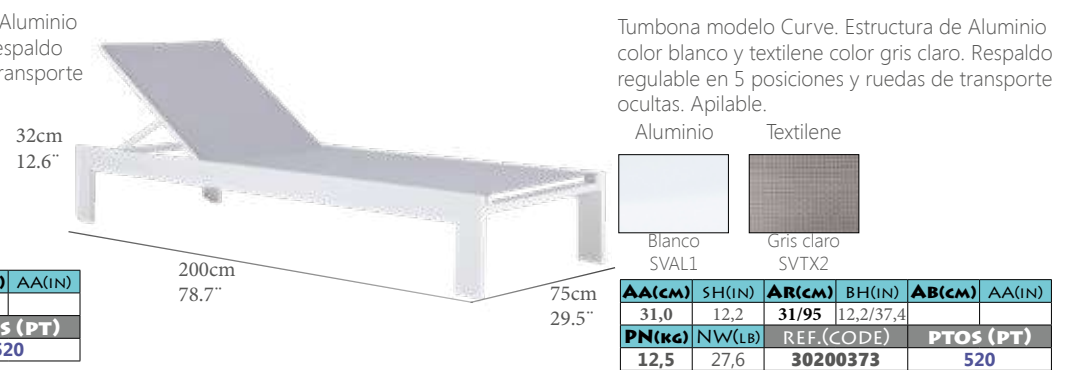

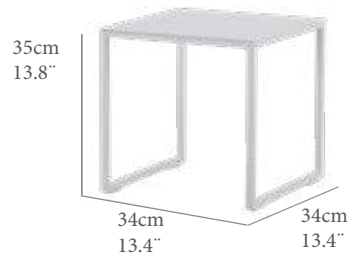

Mesa Auxiliar modelo Oslo. Estructura de aluminio color blanco y encimera en aluminio color blanco.



GT(cm)	TT(IN)	AL(cm)	FH(IN)
0,3	0,1	33,0	13,0
PN(kg)	NW(LB)	REF.(CODE)	PTOS (PT)
1,7	3,7	30200324	88

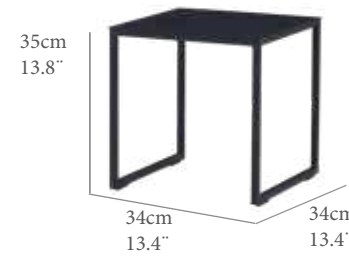

Mesa Auxiliar modelo Oslo. Estructura de aluminio color gris Antracita y encimera en aluminio color gris Antracita.



GT(cm)	TT(IN)	AL(cm)	FH(IN)
0,3	0,1	33,0	13,0
PN(kg)	NW(LB)	REF.(CODE)	PTOS (PT)
1,7	3,7	30200281	88

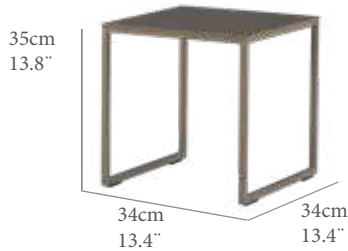

Mesa Auxiliar modelo Oslo. Estructura de aluminio color Taupe y encimera en aluminio color Taupe.



GT(cm)	TT(IN)	AL(cm)	FH(IN)
0,3	0,1	33,0	13,0
PN(kg)	NW(LB)	REF.(CODE)	PTOS (PT)
1,7	3,7	30200279	88

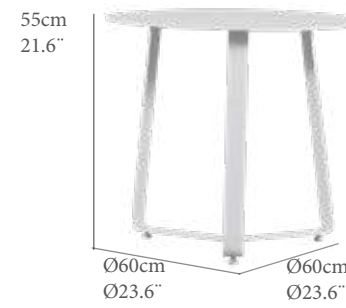

Mesa Auxiliar modelo June. Estructura de aluminio color blanco y encimera en aluminio color blanco.



GT(cm)	TT(IN)	AL(cm)	FH(IN)
0,5	0,2	54,5	21,5
PN(kg)	NW(LB)	REF.(CODE)	PTOS (PT)
5,3	11,7	30200267	140



Mesa auxiliar modelo Hadar. Estructura de Aluminio color blanco Top en aluminio laminado 5mm.. Alta resistencia a la intemperie.



GT(cm)	TT(IN)	AL(cm)	FH(IN)
0,3	0,1	45,0	17,7
PN(kg)	NW(LB)	REF.(CODE)	PTOS (PT)
3,9	8,6	30200872	220



Mesa auxiliar modelo Hadar. Estructura de Aluminio color blanco Top en aluminio laminado 5mm.. Alta resistencia a la intemperie.



GT(cm)	TT(IN)	AL(cm)	FH(IN)
0,3	0,1	40,0	15,7
PN(kg)	NW(LB)	REF.(CODE)	PTOS (PT)
5,0	11,0	30200873	264



Mesa auxiliar modelo Hadar. Estructura de Aluminio color antracita Top en aluminio laminado 5mm.. Alta resistencia a la intemperie.



GT(cm)	TT(IN)	AL(cm)	FH(IN)
0,3	0,1	45,0	17,7
PN(kg)	NW(LB)	REF.(CODE)	PTOS (PT)
3,9	8,6	30200840	220



Mesa auxiliar modelo Hadar. Estructura de Aluminio color antracita Top en aluminio laminado 5mm.. Alta resistencia a la intemperie.



GT(cm)	TT(IN)	AL(cm)	FH(IN)
0,3	0,1	40,0	15,7
PN(kg)	NW(LB)	REF.(CODE)	PTOS (PT)
5,0	11,0	30200841	264

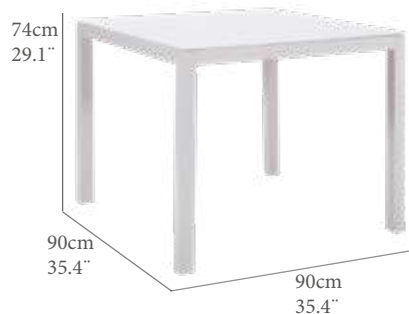

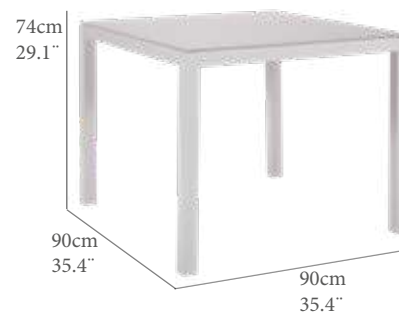

Mesa cuadrada modelo concept. Estructura de aluminio color blanco y encimera en cristal templado color blanco mate. Requiere montaje.

Aluminio		Cristal	
		Blanco	Blanco
SVAL1	SVCT1		
GT(cm)	TT(IN)	AL(cm)	FH(IN)
0,8	0,3	69,0	27,2
PN(kg)	NW(LB)	REF.(CODE)	PTOS (PT)
21,6	47,6	30200318	400



Mesa cuadrada modelo concept. Estructura de aluminio color blanco y encimera en cristal templado color Gris claro. Requiere montaje.

Aluminio		Cristal	
		Blanco	Gris claro
SVAL1	SVCT4		
GT(cm)	TT(IN)	AL(cm)	FH(IN)
0,8	0,3	69,0	27,2
PN(kg)	NW(LB)	REF.(CODE)	PTOS (PT)
21,6	47,6	30200398	400

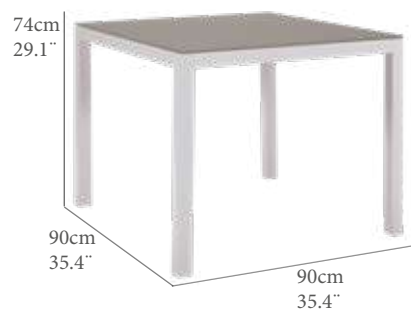

Mesa cuadrada modelo concept. Estructura de aluminio color blanco y encimera en cristal templado color Taupe. Requiere montaje.

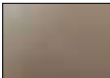
Aluminio		Cristal	
		Blanco	Taupe
SVAL1	SVCT3		
GT(cm)	TT(IN)	AL(cm)	FH(IN)
0,8	0,3	69,0	27,2
PN(kg)	NW(LB)	REF.(CODE)	PTOS (PT)
21,6	47,6	30200319	400

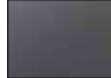
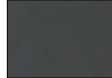

Mesa cuadrada modelo concept. Estructura de aluminio color antracita y encimera en cristal templado color antracita. Requiere montaje.

Aluminio		Cristal	
		Antracita	Antracita
SVAL4	SVCT6		
GT(cm)	TT(IN)	AL(cm)	FH(IN)
0,8	0,3	69,0	27,2
PN(kg)	NW(LB)	REF.(CODE)	PTOS (PT)
21,6	47,6	30200408	400





Mesa rectangular modelo concept. Estructura de aluminio color blanco y encimera en cristal templado color blanco mate. Requiere montaje.

Aluminio		Cristal	
		Blanco	Blanco
SVAL1	SVCT1		
GT(cm)	TT(IN)	AL(cm)	FH(IN)
0,8	0,3	69,0	27,2
PN(kg)	NW(LB)	REF.(CODE)	PTOS (PT)
33,8	74,5	30200305	580

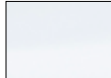

Mesa rectangular modelo concept. Estructura de aluminio color blanco y encimera en cristal templado color Gris claro. Requiere montaje.

Aluminio		Cristal	
		Blanco	Gris claro
SVAL1	SVCT4		
GT(cm)	TT(IN)	AL(cm)	FH(IN)
0,8	0,3	69,0	27,2
PN(kg)	NW(LB)	REF.(CODE)	PTOS (PT)
33,8	74,5	30200421	580



Mesa rectangular modelo concept. Estructura de aluminio color blanco y encimera en cristal templado color Taupe. Requiere montaje.

Aluminio		Cristal	
		Blanco	Taupe
SVAL1	SVCT3		
GT(cm)	TT(IN)	AL(cm)	FH(IN)
0,8	0,3	69,0	27,2
PN(kg)	NW(LB)	REF.(CODE)	PTOS (PT)
33,8	74,5	30200306	580

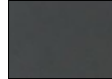

Mesa rectangular modelo concept. Estructura de aluminio color antracita y encimera en cristal templado color antracita. Requiere montaje.

Aluminio		Cristal	
		Antracita	Antracita
SVAL4	SVCT6		
GT(cm)	TT(IN)	AL(cm)	FH(IN)
0,8	0,3	69,0	27,2
PN(kg)	NW(LB)	REF.(CODE)	PTOS (PT)
33,8	74,5	30200409	580

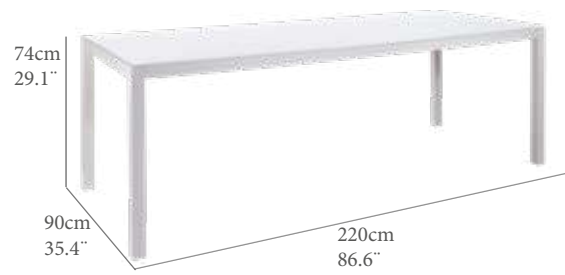

Mesa rectangular modelo concept. Estructura de aluminio color blanco y encimera en cristal templado color blanco mate. Requiere montaje.

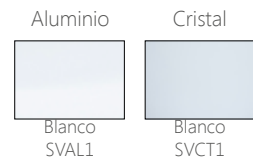

GT(cm)	TT(IN)	AL(cm)	FH(IN)
0,8	0,3	69,0	27,2
PN(kg)	NW(LB)	REF.(CODE)	PTOS (PT)
47,0	103,6	30200423	746

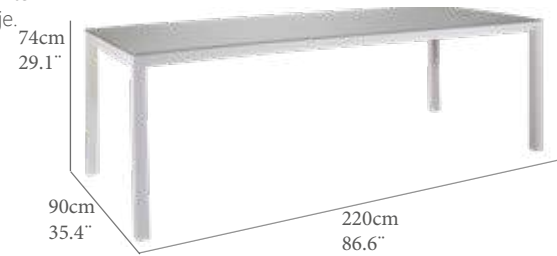

Mesa rectangular modelo concept. Estructura de aluminio color blanco y encimera en cristal templado color Gris claro. Requiere montaje.



GT(cm)	TT(IN)	AL(cm)	FH(IN)
0,8	0,3	69,0	27,2
PN(kg)	NW(LB)	REF.(CODE)	PTOS (PT)
47,0	103,6	30200426	746

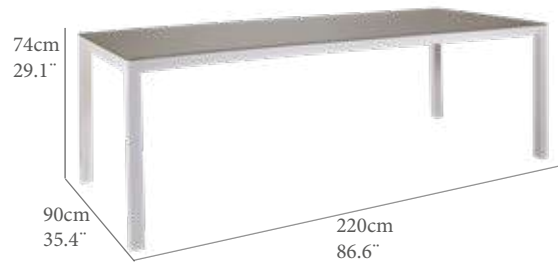

Mesa rectangular modelo concept. Estructura de aluminio color blanco y encimera en cristal templado color Taupe. Requiere montaje.



GT(cm)	TT(IN)	AL(cm)	FH(IN)
0,8	0,3	69,0	27,2
PN(kg)	NW(LB)	REF.(CODE)	PTOS (PT)
47,0	103,6	30200424	746



Mesa rectangular modelo concept. Estructura de aluminio color antracita y encimera en cristal templado color antracita. Requiere montaje.

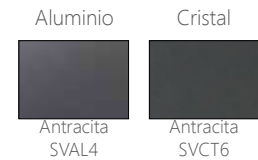

GT(cm)	TT(IN)	AL(cm)	FH(IN)
0,8	0,3	69,0	27,2
PN(kg)	NW(LB)	REF.(CODE)	PTOS (PT)
47,0	103,6	30200410	746

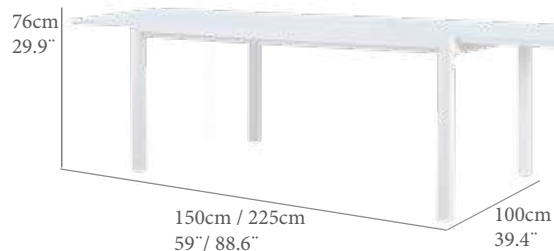

Mesa rectangular extensible modelo concept. Estructura de aluminio color blanco y encimera en cristal templado color blanco. Sistema de apertura manual. Requiere montaje.



GT(cm)	TT(IN)	AL(cm)	FH(IN)
0,5	0,2	69,0	27,2
PN(kg)	NW(LB)	REF.(CODE)	PTOS (PT)
45,6	100,5	30200316	1110



Mesa rectangular extensible modelo concept. Estructura de aluminio color blanco y encimera en cristal templado color blanco. Sistema de apertura manual. Requiere montaje.



GT(cm)	TT(IN)	AL(cm)	FH(IN)
0,5	0,2	69,0	27,2
PN(kg)	NW(LB)	REF.(CODE)	PTOS (PT)
58,0	127,9	30200303	1250



Mesa rectangular extensible modelo concept. Estructura de aluminio color blanco y encimera en cristal templado color gris claro. Sistema de apertura manual. Requiere montaje.



GT(cm)	TT(IN)	AL(cm)	FH(IN)
0,5	0,2	69,0	27,2
PN(kg)	NW(LB)	REF.(CODE)	PTOS (PT)
45,6	100,5	30200429	1110



Mesa rectangular extensible modelo concept. Estructura de aluminio color blanco y encimera en cristal templado color gris claro. Sistema de apertura manual. Requiere montaje.



GT(cm)	TT(IN)	AL(cm)	FH(IN)
0,5	0,2	69,0	27,2
PN(kg)	NW(LB)	REF.(CODE)	PTOS (PT)
58,0	127,9	30200431	1250

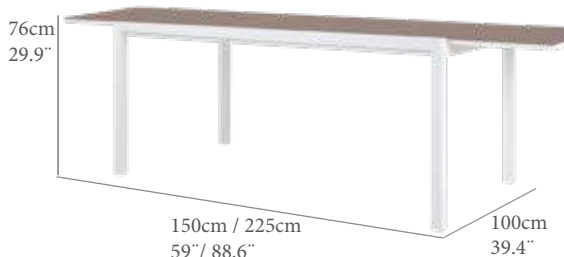

Mesa rectangular extensible modelo concept. Estructura de aluminio color blanco y encimera en cristal templado color taupe. Sistema de apertura manual. Requiere montaje.



GT(cm)	TT(IN)	AL(cm)	FH(IN)
0,5	0,2	69,0	27,2
PN(kg)	NW(LB)	REF.(CODE)	PTOS (PT)
45,6	100,5	30200315	1110



Mesa rectangular extensible modelo concept. Estructura de aluminio color blanco y encimera en cristal templado color taupe. Sistema de apertura manual. Requiere montaje.



GT(cm)	TT(IN)	AL(cm)	FH(IN)
0,5	0,2	69,0	27,2
PN(kg)	NW(LB)	REF.(CODE)	PTOS (PT)
58,0	127,9	30200304	1250



Mesa rectangular extensible modelo concept. Estructura de aluminio color antracita y encimera en cristal templado color antracita. Sistema de apertura manual. Requiere montaje.



GT(cm)	TT(IN)	AL(cm)	FH(IN)
0,5	0,2	69,0	27,2
PN(kg)	NW(LB)	REF.(CODE)	PTOS (PT)
45,6	100,5	30200411	1110



Mesa rectangular extensible modelo concept. Estructura de aluminio color antracita y encimera en cristal templado color antracita. Sistema de apertura manual. Requiere montaje.



GT(cm)	TT(IN)	AL(cm)	FH(IN)
0,5	0,2	69,0	27,2
PN(kg)	NW(LB)	REF.(CODE)	PTOS (PT)
58,0	127,9	30200412	1250



Daybed modelo Concept. Estructura de aluminio pintada en color blanco. Respaldo con dos zonas regulación independientes. Cubierta superior con regulación lateral en poliéster reforzado con Teflón. Terminación del colchón en poliéil náutica y texti-lene en la parte inferior para una fácil evacuación.

AA(cm)	SH(IN)	AR(cm)	BH(IN)	AB(cm)	AA(IN)
45,0	17,7	45/96	17,7/37,8		
PN(kg)	NW(LB)	REF.(CODE)	PTOS (PT)		
63,0	138,9	30200225	2100		

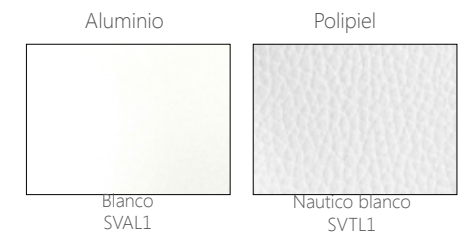

Daybed modelo **Concept-style**. Estructura de aluminio pintada en color blanco. **Trasera con Kit de reducción solar trasera**. Respaldo con dos zonas regulación independientes. Cubierta superior con regulación lateral en tela acrílica. Colchón en polipiel náutica con grosor de 12centímetros. Sistema inferior de drenaje y transpiración. Desenfundable. Cojines auxiliares incluidos.

AA(cm)	SH(IN)	AR(cm)	BH(IN)	AB(cm)	AA(IN)
45,0	17,7	45/96	17,7/37,8		
PN(kg)	NW(LB)	REF.(CODE)	PTOS (PT)		
78,0	172,0	33000010	2480		

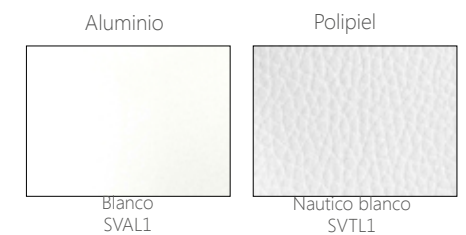

Daybed modelo Concept exclusive. Estructura de aluminio pintada en color taupe. Respaldo con dos zonas regulación independientes. Cubierta superior con regulación lateral en poliéster reforzado con Teflón. Colchón en tela acrílica de alta calidad con alta capacidad del evacuación. y grosor de 12cm color taupe.

AA(cm)	SH(IN)	AR(cm)	BH(IN)	AB(cm)	AA(IN)
45,0	17,7	45/96	17,7/37,8		
PN(kg)	NW(LB)	REF.(CODE)	PTOS (PT)		
63,0	138,9	33000003	2858		



Daybed modelo **Concept-style**. Estructura de aluminio pintada en color taupe. **Trasera con Kit de reducción solar trasera**. Respaldo con dos zonas regulación independientes. Cubierta superior con regulación lateral en tela acrílica. Colchón en tela acrílica de alta calidad con alta capacidad del evacuación. y grosor de 12cm color taupe. Sistema inferior de drenaje y transpiración. Desenfundable. Cojines auxiliares incluidos

AA(cm)	SH(IN)	AR(cm)	BH(IN)	AB(cm)	AA(IN)
45,0	17,7	45/96	17,7/37,8		
PN(kg)	NW(LB)	REF.(CODE)	PTOS (PT)		
78,0	172,0	33000030	3258		





Daybed modelo **Concept exclusive**. Estructura de aluminio pintada en color antracita. Respaldo con dos zonas regulación independientes. Cubierta superior con regulación lateral en poliéster reforzado con Teflón. Colchón en tela acrílica de alta calidad con alta capacidad del evacuación, y grosor de 12cm color antracita

AA(cm)	SH(IN)	AR(cm)	BH(IN)	AB(cm)	AA(IN)
45,0	17,7	45/96	17,7/37,8		
PN(kg)	NW(Lb)	REF.(CODE)	PTOS (PT)		
63,0	138,9	33000005	2858		

Aluminio

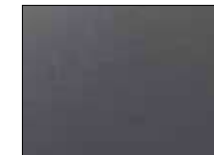

Antracita
SVAL4

Textil



Gris CARTENZA



Daybed modelo **Concept-style**. Estructura de aluminio pintada en color antracita. **Trasera con Kit de reducción solar trasera**. Respaldo con dos zonas regulación independientes. Cubierta superior con regulación lateral en tela acrílica. Colchón en tela acrílica de alta calidad con alta capacidad del evacuación, y grosor de 12cm color antracita. Sistema inferior de drenaje y transpiración. Desenfundable. Cojines auxiliares incluidos

AA(cm)	SH(IN)	AR(cm)	BH(IN)	AB(cm)	AA(IN)
45,0	17,7	45/96	17,7/37,8		
PN(kg)	NW(Lb)	REF.(CODE)	PTOS (PT)		
78,0	172,0	33000035	3258		

Aluminio

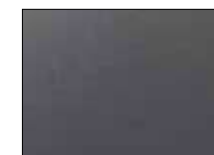

Antracita
SVAL4

Textil



Gris CARTENZA





Sofá rinconera modelo Stryn (6 plazas). Estructura en aluminio laminado de alta calidad color blanco. Cojín de asiento y respaldo color blanco. Grosor de 10cm. Requiere montaje.



AA(cm)	SH(IN)	AB(cm)	AH(IN)	AE(cm)	FH(IN)
40,0	15,7			73,5	28,9
PN(kg)	NW(Lb)	REF.(CODE)	PTOS (PT)		
50,3	110,9	30200550	2222		



Sofá rinconera modelo Stryn (6 plazas). Estructura en aluminio laminado de alta calidad color blanco. Cojín de asiento y respaldo color gris. Grosor de 10cm. Requiere montaje.

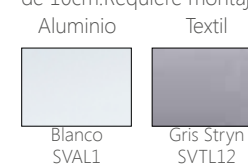

AA(cm)	SH(IN)	AB(cm)	AH(IN)	AE(cm)	FH(IN)
40,0	15,7			73,5	28,9
PN(kg)	NW(Lb)	REF.(CODE)	PTOS (PT)		
50,3	110,9	30200551	2222		



Mesa auxiliar modelo Stryn. Estructura en aluminio color blanco. Encimera en aluminio laminado color blanco Requiere montaje.



GT(cm)	TT(IN)	AL(cm)	FH(IN)
0,3	0,1	28,0	11,0
PN(kg)	NW(Lb)	REF.(CODE)	PTOS (PT)
9,3	20,5	30200552	656



Silla de comedor con brazos Isabelle. Estructura en aluminio color blanco y textilene de doble pared con **Quick dry foam** color gris claro. Alta resistencia a la intemperie. Apilable.

Aluminio Textilene

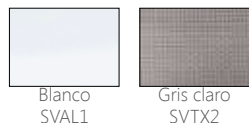

AA(cm)	SH(IN)	AB(cm)	AH(IN)	AE(cm)	FH(IN)
42,0	16,5	64,0	25,2	90	35,4
PN(kg)	NW(LB)	REF.(CODE)	PTOS (PT)		
4,0	8,8	30200683	188		



Silla de comedor con brazos Isabelle. Estructura en aluminio color taupe y textilene de doble pared con **Quick dry foam** color taupe. Alta resistencia a la intemperie. Apilable.

Aluminio Textilene

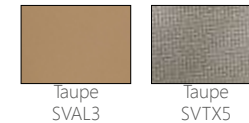

AA(cm)	SH(IN)	AB(cm)	AH(IN)	AE(cm)	FH(IN)
42,0	16,5	64,0	25,2	90	35,4
PN(kg)	NW(LB)	REF.(CODE)	PTOS (PT)		
4,0	8,8	30200684	188		



Taburete alto con brazos Isabelle. Estructura en aluminio color blanco y textilene de doble pared con **Quick dry foam** color gris claro. Alta resistencia a la intemperie. Apilable.

Aluminio Textilene

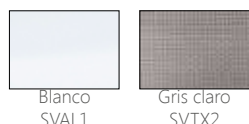

AA(cm)	SH(IN)	AB(cm)	AH(IN)	AE(cm)	FH(IN)
70,5	27,8	91,8	36,1	112	44,1
PN(kg)	NW(LB)	REF.(CODE)	PTOS (PT)		
5,1	11,2	30200689	196		



Taburete alto con brazos Isabelle. Estructura en aluminio color taupe y textilene de doble pared con **Quick dry foam** color taupe. Alta resistencia a la intemperie. Apilable.

Aluminio Textilene



AA(cm)	SH(IN)	AB(cm)	AH(IN)	AE(cm)	FH(IN)
70,5	27,8	91,8	36,1	112	44,1
PN(kg)	NW(LB)	REF.(CODE)	PTOS (PT)		
5,1	11,2	30200690	196		



Mesa redonda de comedor Isabelle. Estructura de aluminio color blanco. Encimera en cristal cerámico de alta durabilidad con acabado "Sky grey". Requiere montaje.

Aluminio Cristal



GT(cm)	TT(IN)	AL(cm)	FH(IN)
0,8	0,3	71,0	28
PN(kg)	NW(LB)	REF.(CODE)	PTOS (PT)
51,0	112,4	30200685	1036



Mesa redonda de comedor Isabelle. Estructura de aluminio color taupe. Encimera en cristal cerámico de alta durabilidad con acabado "Galaxy granit". Requiere montaje.

Aluminio Cristal



GT(cm)	TT(IN)	AL(cm)	FH(IN)
0,8	0,3	71,0	28
PN(kg)	NW(LB)	REF.(CODE)	PTOS (PT)
51,0	112,4	30200686	1036



Mesa redonda de comedor Isabelle. Estructura de aluminio color blanco. Encimera en cristal cerámico de alta durabilidad con acabado "Sky grey". Requiere montaje.

Aluminio Cristal



GT(cm)	TT(IN)	AL(cm)	FH(IN)
0,8	0,3	71,0	28
PN(kg)	NW(LB)	REF.(CODE)	PTOS (PT)
64,5	142,2	30200687	1390



Mesa redonda de comedor Isabelle. Estructura de aluminio color taupe. Encimera en cristal cerámico de alta durabilidad con acabado "Galaxy granit". Requiere montaje.

Aluminio Cristal



GT(cm)	TT(IN)	AL(cm)	FH(IN)
0,8	0,3	71,0	28
PN(kg)	NW(LB)	REF.(CODE)	PTOS (PT)
64,5	142,2	30200688	1390

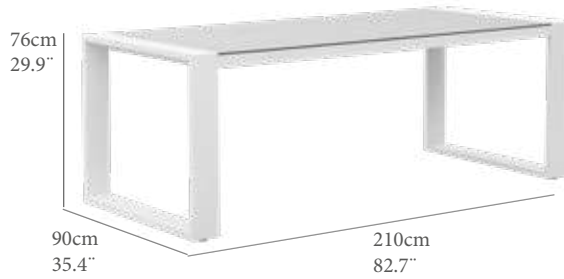

Mesa de comedor rectangular Isabelle. Estructura de aluminio color blanco. Encimera en cristal cerámico de alta durabilidad con acabado "Sky grey". Requiere montaje.

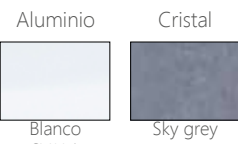

GT(cm)	TT(IN)	AL(cm)	FH(IN)	PTOS (PT)
0,8	0,3	71,0	28	
PN(kg)	NW(LB)	REF.(CODE)		
51,0	112,4	30200680	1258	



Mesa de comedor rectangular Isabelle. Estructura de aluminio color taupe. Encimera en cristal cerámico de alta durabilidad con acabado "Galaxy granit". Requiere montaje.

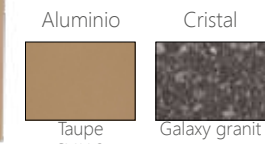

GT(cm)	TT(IN)	AL(cm)	FH(IN)	PTOS (PT)
0,8	0,3	71,0	28	
PN(kg)	NW(LB)	REF.(CODE)		
51,0	112,4	30200681	1258	

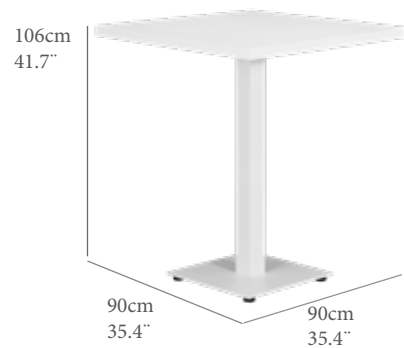

Mesa alta cuadrada Isabelle. Estructura de aluminio color blanco y top de aluminio color blanco. Requiere montaje.



GT(cm)	TT(IN)	AL(cm)	FH(IN)	PTOS (PT)
4,0	1,6	102	40,2	
PN(kg)	NW(LB)	REF.(CODE)		
34,3	75,6	30200691	596	

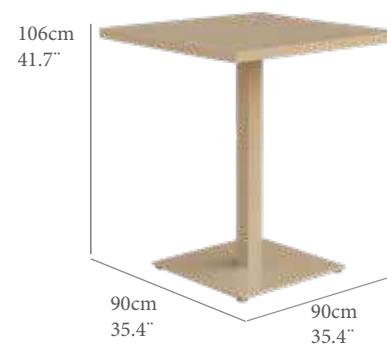

Mesa alta cuadrada Isabelle. Estructura de aluminio color taupe y top de aluminio color taupe. Requiere montaje.

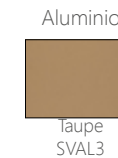

GT(cm)	TT(IN)	AL(cm)	FH(IN)	PTOS (PT)
4,0	1,6	102	40,2	
PN(kg)	NW(LB)	REF.(CODE)		
34,3	75,6	30200692	596	

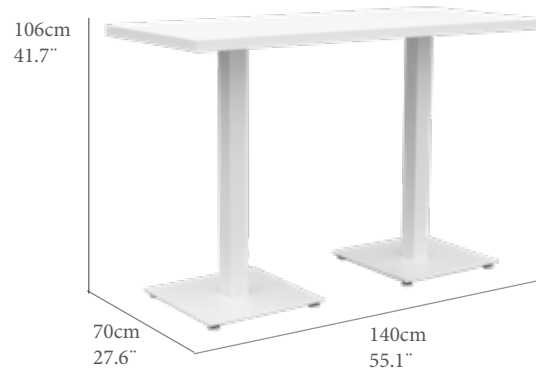

Mesa alta rectangular Isabelle. Estructura de aluminio color blanco y top de aluminio color blanco. Requiere montaje.



GT(cm)	TT(IN)	AL(cm)	FH(IN)	PTOS (PT)
4,0	1,6	102	40,2	
PN(kg)	NW(LB)	REF.(CODE)		
49,8	109,8	30200693	676	

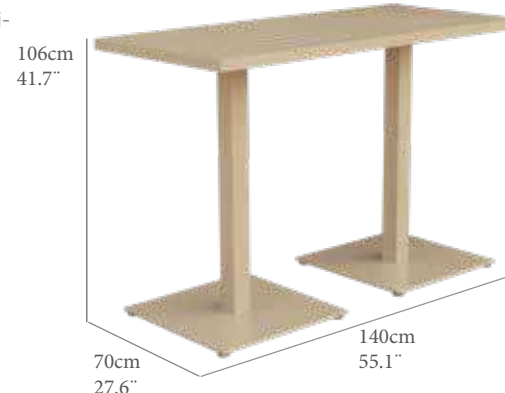

Mesa alta rectangular Isabelle. Estructura de aluminio color taupe y top de aluminio color taupe. Requiere montaje.

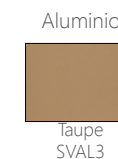

GT(cm)	TT(IN)	AL(cm)	FH(IN)	PTOS (PT)
4,0	1,6	102	40,2	
PN(kg)	NW(LB)	REF.(CODE)		
49,8	109,8	30200694	676	

Sofá de 1 plaza modelo Antares
Estructura en aluminio color Antracita. Cojín de asiento y respaldo color gris Tempo. Cojín de asiento de 15cm. Cojín de respaldo de 15cm. Waterproof.

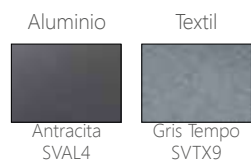

AA(CM)	SH(IN)	AB(CM)	AH(IN)	AE(CM)	FH(IN)
33,5	13,2	54,0	21,3	54,0	21,3
PN(KG)	NW(LB)	REF.(CODE)	PTOS (PT)		
28,0	61,8	30200563	826		

Sofá de 3 plazas modelo Antares
Estructura en aluminio color Antracita. Cojín de asiento y respaldo color gris Tempo. Cojín de asiento de 15cm. Cojín de respaldo de 15cm. Waterproof.

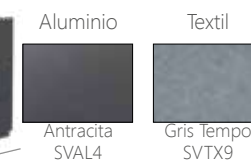

AA(CM)	SH(IN)	AB(CM)	AH(IN)	AE(CM)	FH(IN)
33,5	13,2	54,0	21,3	54,0	21,3
PN(KG)	NW(LB)	REF.(CODE)	PTOS (PT)		
54,2	119,7	30200564	1534		

Modulo 3 plazas brazo izquierdo Antares
Estructura en aluminio color Antracita. Cojín de asiento y respaldo color gris Tempo. Cojín de asiento de 15cm. Cojín de respaldo de 15cm. Waterproof.

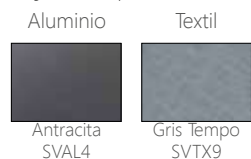

AA(CM)	SH(IN)	AB(CM)	AH(IN)	AE(CM)	FH(IN)
33,5	13,2	54,0	21,3	54,0	21,3
PN(KG)	NW(LB)	REF.(CODE)	PTOS (PT)		
48,3	106,6	30200566	1710		

Modulo 3 plazas brazo derecho Antares
Estructura en aluminio color Antracita. Cojín de asiento y respaldo color gris Tempo. Cojín de asiento de 15cm. Cojín de respaldo de 15cm. Waterproof.



AA(CM)	SH(IN)	AB(CM)	AH(IN)	AE(CM)	FH(IN)
33,5	13,2	54,0	21,3	54,0	21,3
PN(KG)	NW(LB)	REF.(CODE)	PTOS (PT)		
48,3	106,6	30200567	1710		

Modulo lounge brazo izquierdo Antares
Estructura en aluminio color Antracita. Cojín de asiento y respaldo color gris Tempo. Cojín de asiento de 15cm. Cojín de respaldo de 15cm. Waterproof.



AA(CM)	SH(IN)	AB(CM)	AH(IN)	AE(CM)	FH(IN)
33,5	13,2	54,0	21,3	54,0	21,3
PN(KG)	NW(LB)	REF.(CODE)	PTOS (PT)		
50,3	111,1	30200568	1630		

Modulo lounge brazo derecho Antares
Estructura en aluminio color Antracita. Cojín de asiento y respaldo color gris Tempo. Cojín de asiento de 15cm. Cojín de respaldo de 15cm. Waterproof.

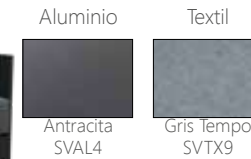

AA(CM)	SH(IN)	AB(CM)	AH(IN)	AE(CM)	FH(IN)
33,5	13,2	54,0	21,3	54,0	21,3
PN(KG)	NW(LB)	REF.(CODE)	PTOS (PT)		
50,3	111,1	30200569	1630		



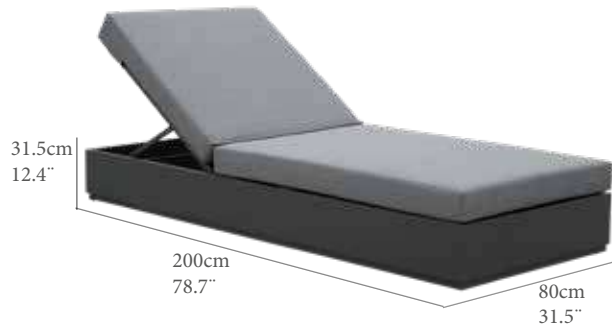

Tumbona modelo Antares.
Estructura en aluminio color Antracita.
Cojin de asiento y respaldo color gris Tempo. Cojin waterproof de 10cm.
Ruedas de transporte incluidas.



AA(cm)	SH(IN)	AR(cm)	BH(IN)	AB(cm)	AA(IN)
31,5	12,4	31/79	12,4/31,3		
PN(kg)	NW(LB)	REF.(CODE)	PTOS (PT)		
25,9	57,2	30200570	960		

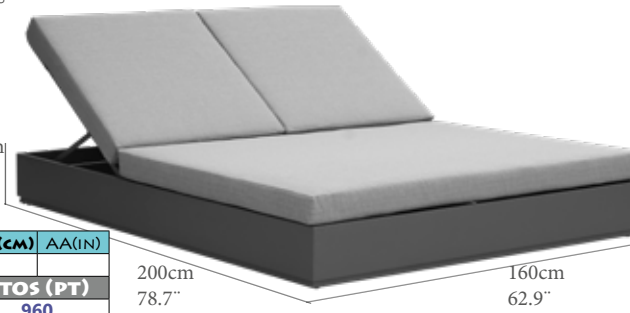

Daybed modelo Antares.
Estructura en aluminio color Antracita.
Cojin de asiento y respaldo color gris Tempo. Cojin waterproof de 10cm.
Ruedas de transporte incluidas.



AA(cm)	SH(IN)	AR(cm)	BH(IN)	AB(cm)	AA(IN)
31,5	12,4	31/79	12,4/31,3		
PN(kg)	NW(LB)	REF.(CODE)	PTOS (PT)		
31,4	69,3	30200571	1534		

Mesa Auxiliar modelo Antares.
Estructura de aluminio color antracita y top en lamas de aluminio color Antracita.



GT(cm)	TT(IN)	AL(cm)	FH(IN)
0,3	0,1	27,5	10,8
PN(kg)	NW(LB)	REF.(CODE)	PTOS (PT)
13,9	30,7	30200565	448

Mesa Auxiliar modelo Antares.
Estructura de aluminio color antracita y top en aluminio color Antracita.
Top con sistema de elevacion en 3 zonas independientes.



GT(cm)	TT(IN)	AL(cm)	FH(IN)
0,5	0,2	36,0	14,2
PN(kg)	NW(LB)	REF.(CODE)	PTOS (PT)
22,0	48,6	30200562	672

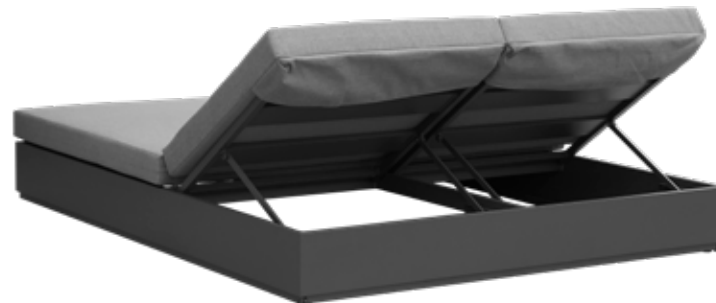



Sofá de 1 plaza modelo New Oslo Estructura en aluminio color blanco. Cojín de asiento y respaldo color blanco. Cojín de asiento de 10cm. Cojín de respaldo de 12cm.



AA(cm)	SH(IN)	AB(cm)	AH(IN)	AE(cm)	FH(IN)
43,0	16,9	67,5	26,6	67,5	26,6
PN(kg)	NW(LB)	REF.(CODE)	PTOS (PT)		
10,2	22,5	30200273	468		



Sofá de 1 plaza modelo New Oslo Estructura en aluminio color blanco. Cojín de asiento y respaldo color gris. Cojín de asiento de 10cm. Cojín de respaldo de 12cm.



AA(cm)	SH(IN)	AB(cm)	AH(IN)	AE(cm)	FH(IN)
43,0	16,9	67,5	26,6	67,5	26,6
PN(kg)	NW(LB)	REF.(CODE)	PTOS (PT)		
10,2	22,5	30200274	468		



Sofá de 2 plazas modelo New Oslo Estructura en aluminio color blanco. Cojín de asiento y respaldo color blanco. Cojín de asiento de 10cm. Cojín de respaldo de 12cm.



AA(cm)	SH(IN)	AB(cm)	AH(IN)	AE(cm)	FH(IN)
43,0	16,9	67,5	26,6	67,5	26,6
PN(kg)	NW(LB)	REF.(CODE)	PTOS (PT)		
13,8	30,4	30200275	680		



Sofá de 2 plazas modelo New Oslo Estructura en aluminio color blanco. Cojín de asiento y respaldo color gris. Cojín de asiento de 10cm. Cojín de respaldo de 12cm.



AA(cm)	SH(IN)	AB(cm)	AH(IN)	AE(cm)	FH(IN)
43,0	16,9	67,5	26,6	67,5	26,6
PN(kg)	NW(LB)	REF.(CODE)	PTOS (PT)		
13,8	30,4	30200276	680		



Sofá de 3 plazas modelo New Oslo Estructura en aluminio color blanco. Cojín de asiento y respaldo color blanco. Cojín de asiento de 10cm. Cojín de respaldo de 12cm.



AA(cm)	SH(IN)	AB(cm)	AH(IN)	AE(cm)	FH(IN)
43,0	16,9	67,5	26,6	67,5	26,6
PN(kg)	NW(LB)	REF.(CODE)	PTOS (PT)		
16,2	35,7	30200277	906		



Sofá de 3 plazas modelo New Oslo Estructura en aluminio color blanco. Cojín de asiento y respaldo color gris. Cojín de asiento de 10cm. Cojín de respaldo de 12cm.



AA(cm)	SH(IN)	AB(cm)	AH(IN)	AE(cm)	FH(IN)
43,0	16,9	67,5	26,6	67,5	26,6
PN(kg)	NW(LB)	REF.(CODE)	PTOS (PT)		
16,2	35,7	30200278	906		



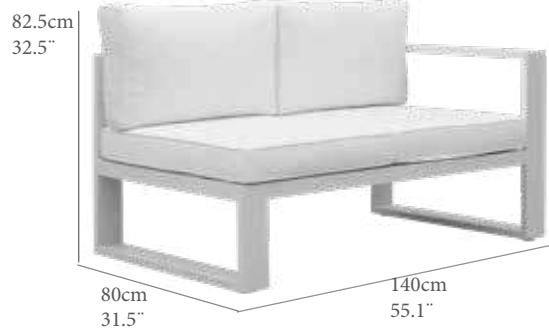

Modulo lateral dos plazas brazo izquierdo modelo New Oslo. Estructura en aluminio color blanco. Cojin de asiento y respaldo color blanco. Cojin de asiento de 10cm. Cojin respaldo 12cm.



AA(cm)	SH(IN)	AB(cm)	AH(IN)	AE(cm)	FH(IN)
43,0	16,9	67,5	26,6	67,5	26,6
PN(kg)	NW(Lb)	REF.(CODE)	PTOS (PT)		
11,6	25,6	39600106	594		



Modulo lateral dos plazas brazo izquierdo modelo New Oslo. Estructura en aluminio color blanco. Cojin de asiento y respaldo color gris. Cojin de asiento de 10cm. Cojin respaldo 12cm.

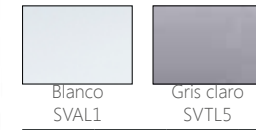

AA(cm)	SH(IN)	AB(cm)	AH(IN)	AE(cm)	FH(IN)
43,0	16,9	67,5	26,6	67,5	26,6
PN(kg)	NW(Lb)	REF.(CODE)	PTOS (PT)		
11,6	25,6	39600130	594		

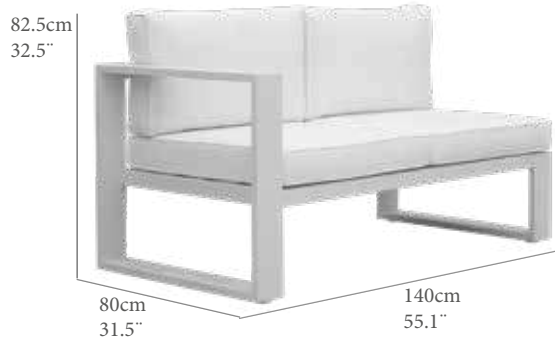

Modulo lateral dos plazas brazo derecho modelo New Oslo. Estructura en aluminio color blanco. Cojin de asiento y respaldo color blanco. Cojin de asiento de 10cm. Cojin respaldo 12cm.

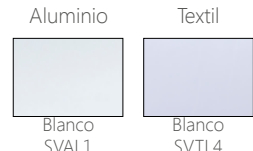

AA(cm)	SH(IN)	AB(cm)	AH(IN)	AE(cm)	FH(IN)
43,0	16,9	67,5	26,6	67,5	26,6
PN(kg)	NW(Lb)	REF.(CODE)	PTOS (PT)		
11,4	25,1	39600107	594		



Modulo lateral dos plazas brazo derecho modelo New Oslo. Estructura en aluminio color blanco. Cojin de asiento y respaldo color gris. Cojin de asiento de 10cm. Cojin respaldo de 12cm.

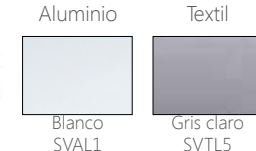

AA(cm)	SH(IN)	AB(cm)	AH(IN)	AE(cm)	FH(IN)
43,0	16,9	67,5	26,6	67,5	26,6
PN(kg)	NW(Lb)	REF.(CODE)	PTOS (PT)		
11,4	25,1	39600131	594		

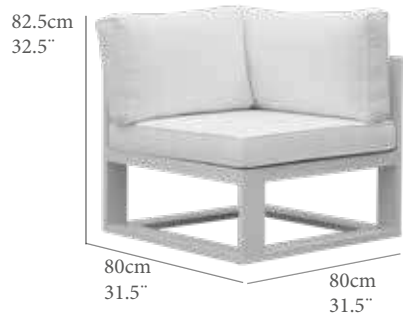

Modulo esquinero modelo New Oslo. Estructura en aluminio color blanco. Cojin de asiento y respaldo color blanco. Cojin de asiento de 10cm. Cojin de respaldo de 12cm.

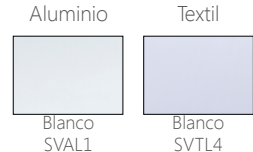

AA(cm)	SH(IN)	AB(cm)	AH(IN)	AE(cm)	FH(IN)
43,0	16,9	67,5	26,6	67,5	26,6
PN(kg)	NW(Lb)	REF.(CODE)	PTOS (PT)		
9,7	21,4	39600108	490		



Modulo esquinero modelo New Oslo. Estructura en aluminio color blanco. Cojin de asiento y respaldo color gris. Cojin de asiento de 10cm. Cojin de respaldo de 12cm.

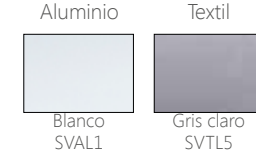

AA(cm)	SH(IN)	AB(cm)	AH(IN)	AE(cm)	FH(IN)
43,0	16,9	67,5	26,6	67,5	26,6
PN(kg)	NW(Lb)	REF.(CODE)	PTOS (PT)		
9,7	21,4	39600132	490		

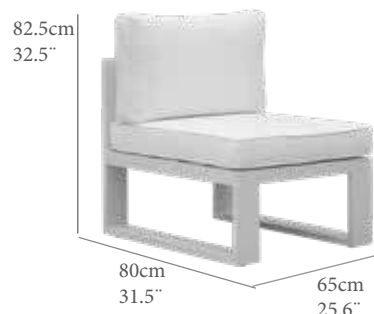

Modulo de ampliación modelo New Oslo. Estructura en aluminio color blanco. Cojin de asiento y respaldo color blanco. Cojin de asiento de 10cm. Cojin de respaldo de 12cm.



AA(cm)	SH(IN)	AB(cm)	AH(IN)	AE(cm)	FH(IN)
43,0	16,9	67,5	26,6	67,5	26,6
PN(kg)	NW(Lb)	REF.(CODE)	PTOS (PT)		
7,1	15,7	39600109	326		



Modulo de ampliación modelo New Oslo. Estructura en aluminio color blanco. Cojin de asiento y respaldo color gris. Cojin de asiento de 10cm. Cojin de respaldo de 12cm.

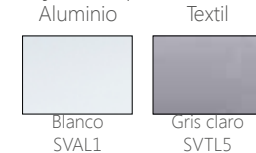

AA(cm)	SH(IN)	AB(cm)	AH(IN)	AE(cm)	FH(IN)
43,0	16,9	67,5	26,6	67,5	26,6
PN(kg)	NW(Lb)	REF.(CODE)	PTOS (PT)		
7,1	15,7	39600133	326		





Tumbona de 1 plaza modelo New Oslo. Estructura en aluminio color blanco. Cojín de tumbona de 8cm de grosor color blanco. Con rueda oculta de transporte..
Aluminio Textil

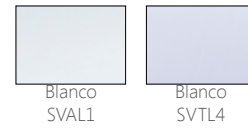

AA(cm)	SH(IN)	AR(cm)	BH(IN)	AB(cm)	AA(IN)
38,0	15,0	30/80	11,8/31,5		
PN(kg)	NW(LB)	REF.(CODE)	PTOS (PT)		
18,8	41,4	30200282	652		



Tumbona de 1 plaza modelo New Oslo. Estructura en aluminio color blanco. Cojín de tumbona de 8cm de grosor color gris claro. Con rueda oculta de transporte..
Aluminio Textil



AA(cm)	SH(IN)	AR(cm)	BH(IN)	AB(cm)	AA(IN)
38,0	15,0	30/80	11,8/31,5		
PN(kg)	NW(LB)	REF.(CODE)	PTOS (PT)		
18,8	41,4	30200283	652		



Daybed 2 plazas New Oslo. Estructura en aluminio color blanco. Cojinería de 10cm de grosor color blanco. Respaldos con regulación independiente.
Aluminio Textil

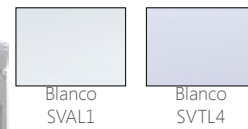

AA(cm)	SH(IN)	AR(cm)	BH(IN)	AB(cm)	AA(IN)
40,0	15,7	30/80	11,8/31,5		
PN(kg)	NW(LB)	REF.(CODE)	PTOS (PT)		
31,5	69,4	30200284	1298		



Daybed 2 plazas New Oslo. Estructura en aluminio color blanco. Cojinería de 10cm de grosor color gris. Respaldos con regulación independiente.
Aluminio Textil



AA(cm)	SH(IN)	AR(cm)	BH(IN)	AB(cm)	AA(IN)
40,0	15,7	30/80	11,8/31,5		
PN(kg)	NW(LB)	REF.(CODE)	PTOS (PT)		
31,5	69,4	30200285	1298		

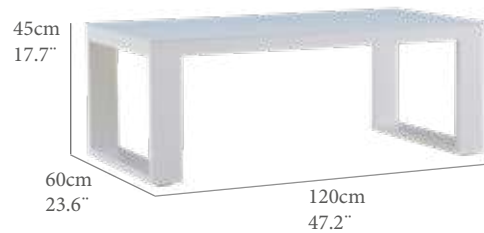

Mesa Auxiliar modelo New Oslo. Estructura de aluminio color blanco y encimera en cristal templado de 8mm color blanco mate.
Aluminio Cristal



GT(cm)	TT(IN)	AL(cm)	FH(IN)
0,5	0,2	40,0	15,7
PN(kg)	NW(LB)	REF.(CODE)	PTOS (PT)
13,7	30,2	39600105	326



Mesa lateral para tumbona o Daybed modelo New Oslo. Estructura de aluminio color blanco. Encimera en aluminio color blanco.
Aluminio





GT(cm)	TT(IN)	AL(cm)	FH(IN)
0,5	0,2	49,5	19,5
PN(kg)	NW(LB)	REF.(CODE)	PTOS (PT)
6,0	13,2	30200286	160

Sofá de 1 plaza modelo Hadar. Estructura en aluminio greige y cuerda gris claro.Revestimiento en textil gris claro. Alta resistencia a la intemperie.

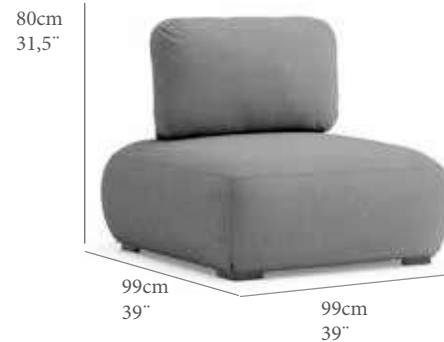

Estructura		Textil			
	Gris S,light SVAL8		Gris claro SVTL22		
AA(cm)	SH(IN)	AB(cm)	AH(IN)	AE(cm)	FH(IN)
43	16.9			77	30.3
PN(kg)	NW(LB)	REF.(CODE)		PTOS (PT)	
18.7	41.2	30200830		842	





Estructura		Textil			
	Antracita SVAL4		Gris flurotita SVTL30		
AA(cm)	SH(IN)	AB(cm)	AH(IN)	AE(cm)	FH(IN)
43	16.9			77	30.3
PN(kg)	NW(LB)	REF.(CODE)		PTOS (PT)	
18.7	41.2	30200835		842	

Sofá esquinero modelo Hadar. Estructura en aluminio greige y cuerda gris claro.Revestimiento en textil gris claro. Alta resistencia a la intemperie.

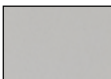

Estructura		Textil			
	Gris S,light SVAL8		Gris claro SVTL22		
AA(cm)	SH(IN)	AB(cm)	AH(IN)	AE(cm)	FH(IN)
43	16.9			77	30.3
PN(kg)	NW(LB)	REF.(CODE)		PTOS (PT)	
31.8	70.1	30200831		1520	



Estructura		Textil			
	Antracita SVAL4		Gris flurotita SVTL30		
AA(cm)	SH(IN)	AB(cm)	AH(IN)	AE(cm)	FH(IN)
43	16.9			77	30.3
PN(kg)	NW(LB)	REF.(CODE)		PTOS (PT)	
31.8	70.1	30200836		1520	



Sofá dos plazas modelo Hadar. Estructura en aluminio greige y cuerda gris claro.Revestimiento en textil gris claro. Alta resistencia a la intemperie.

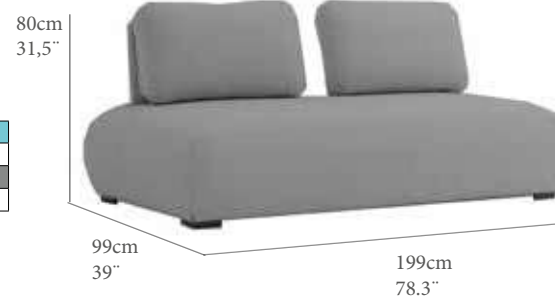

Estructura		Textil			
	Gris S,light SVAL8		Gris claro SVTL22		
AA(cm)	SH(IN)	AB(cm)	AH(IN)	AE(cm)	FH(IN)
43	16.9			77	30.3
PN(kg)	NW(LB)	REF.(CODE)		PTOS (PT)	
36	79.3	30200834		1540	



Sofá dos plazas modelo Hadar. Estructura en aluminio antracita y cuerda antracita. Revestimiento en textil antracita. Alta resistencia a la intemperie.

Estructura		Textil			
	Antracita SVAL4		Gris flurotita SVTL30		
AA(cm)	SH(IN)	AB(cm)	AH(IN)	AE(cm)	FH(IN)
43	16.9			77	30.3
PN(kg)	NW(LB)	REF.(CODE)		PTOS (PT)	
36	79.3	30200839		1540	

Puff con mesa auxiliar modelo Hadar. Estructura en aluminio greige y cuerda gris claro.Revestimiento en textil gris claro. Alta resistencia a la intemperie.



Estructura		Textil			
	Gris S,light SVAL8		Gris claro SVTL22		
AA(cm)	SH(IN)	AB(cm)	AH(IN)	AE(cm)	FH(IN)
43	16.9			43	16.9
PN(kg)	NW(LB)	REF.(CODE)		PTOS (PT)	
18.3	40.3	30200833		884	



Puff con mesa auxiliar modelo Hadar. Estructura en aluminio antracita y cuerda antracita. Revestimiento en textil antracita. Alta resistencia a la intemperie.

Estructura		Textil			
	Antracita SVAL4		Gris flurotita SVTL30		
AA(cm)	SH(IN)	AB(cm)	AH(IN)	AE(cm)	FH(IN)
43	16.9			43	16.9
PN(kg)	NW(LB)	REF.(CODE)		PTOS (PT)	
18.3	40.3	30200838		884	



Tumbona lounge modelo Hadar. Estructura en aluminio greige y cuerda gris claro.Revestimiento en textil gris claro. Alta resistencia a la intemperie.

Estructura Textil



AA(cm)	SH(IN)	AB(cm)	AH(IN)	AE(cm)	FH(IN)
43	16.9			77	30.3
PN(kg)	NW(LB)	REF.(CODE)		PTOS (PT)	
26.9	59.3	30200832		1168	



Tumbona lounge modelo Hadar. Estructura en aluminio antracita y cuerda gris antracita.Revestimiento en textil antracita Alta resistencia a la intemperie.

Estructura Textil



AA(cm)	SH(IN)	AB(cm)	AH(IN)	AE(cm)	FH(IN)
43	16.9			77	30.3
PN(kg)	NW(LB)	REF.(CODE)		PTOS (PT)	
26.9	59.3	30200837		1168	



Mesa auxiliar redonda.Estructura de Aluminio color antracita.. Top en aluminio laminado 5mm gris. Alta resistencia a la intemperie.

Estructura



GT(cm)	TT(IN)	AL(cm)	FH(IN)	
0,3	0,1	45,0	17,7	
PN(kg)	NW(LB)	REF.(CODE)		PTOS (PT)
3,9	8,6	30200840		220



Mesa auxiliar redonda.Estructura de Aluminio color antracita.. Top en aluminio laminado 5mm gris. Alta resistencia a la intemperie.

Estructura



GT(cm)	TT(IN)	AL(cm)	FH(IN)	
0,3	0,1	40,0	15,7	
PN(kg)	NW(LB)	REF.(CODE)		PTOS (PT)
5,0	11,0	30200841		264



Mesa auxiliar redonda.Estructura de Aluminio color gris claro. Top en aluminio laminado 5mm gris. Alta resistencia a la intemperie.

Estructura



GT(cm)	TT(IN)	AL(cm)	FH(IN)	
0,3	0,1	45,0	17,7	
PN(kg)	NW(LB)	REF.(CODE)		PTOS (PT)
3,9	8,6	30200633		220



Mesa auxiliar redonda.Estructura de Aluminio color gris claro. Top en aluminio laminado 5mm gris. Alta resistencia a la intemperie.

Estructura



GT(cm)	TT(IN)	AL(cm)	FH(IN)	
0,3	0,1	40,0	15,7	
PN(kg)	NW(LB)	REF.(CODE)		PTOS (PT)
5,0	11,0	30200634		264



Silla de comedor modelo Viken. Estructura de aluminio color blanco y cuerda elastica en Olefina color gris claro. Cojin de asiento de 5cm color gris claro.



AA(cm)	SH(IN)	AB(cm)	AH(IN)	AE(cm)	FH(IN)
47,0	18,5	64,5	25,4	81,0	31,9
PN(kg)	NW(LB)	REF.(CODE)	PTOS (PT)		
5,7	12,5	30200558	306		



Silla de comedor modelo Viken. Estructura de aluminio color blanco y cuerda elastica en Olefina color Taupe. Cojin de asiento de 5cm color Taupe



AA(cm)	SH(IN)	AB(cm)	AH(IN)	AE(cm)	FH(IN)
47,0	18,5	64,5	25,4	81,0	31,9
PN(kg)	NW(LB)	REF.(CODE)	PTOS (PT)		
5,7	12,5	30200559	306		



Silla de comedor modelo Viken. Estructura de aluminio color antracita y cuerda elastica en Olefina color antracita. Cojin de asiento de 5cm color gris Tempo.



AA(cm)	SH(IN)	AB(cm)	AH(IN)	AE(cm)	FH(IN)
47,0	18,5	64,5	25,4	81,0	31,9
PN(kg)	NW(LB)	REF.(CODE)	PTOS (PT)		
5,7	12,5	30200560	306		

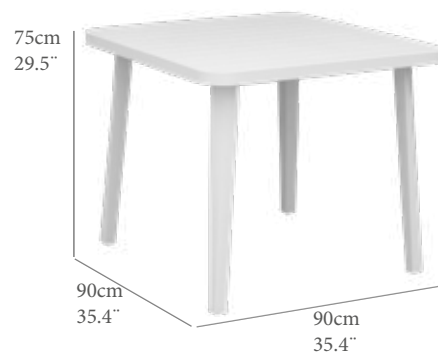

Mesa cuadrada modelo Viken. Estructura de aluminio color blanco y top en lamas de aluminio color blanco . Requiere montaje.



GT(cm)	TT(IN)	AL(cm)	FH(IN)
0,3	0,1	71,0	28,0
PN(kg)	NW(LB)	REF.(CODE)	PTOS (PT)
12,8	28,3	30200555	532



Mesa cuadrada modelo Viken. Estructura de aluminio color Arce y top en lamas de aluminio color Arce. Requiere montaje.



GT(cm)	TT(IN)	AL(cm)	FH(IN)
0,3	0,1	71,0	28,0
PN(kg)	NW(LB)	REF.(CODE)	PTOS (PT)
12,8	28,3	30200556	532

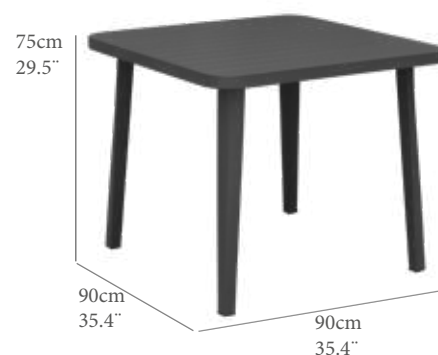

Mesa cuadrada modelo Viken. Estructura de aluminio color Antracita y top en lamas de aluminio color Antracita. Requiere montaje.



GT(cm)	TT(IN)	AL(cm)	FH(IN)
0,3	0,1	71,0	28,0
PN(kg)	NW(LB)	REF.(CODE)	PTOS (PT)
12,8	28,3	30200557	532



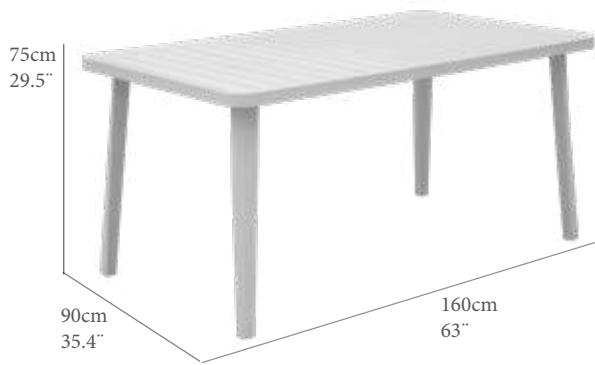

Mesa rectangular modelo Viken.
Estructura de aluminio color blanco y top en lamas de aluminio color blanco.
Requiere montaje.

Aluminio



Blanco
SVAL1

GT(cm)	TT(IN)	AL(cm)	FH(IN)	PN(kg)	NW(LB)	REF.(CODE)	PTOS (PT)
0,3	0,1	71,0	28,0	15,7	34,7	30200417	760



Mesa rectangular modelo Vken.
Estructura de aluminio color Arce y top en lamas de aluminio color Arce.
Requiere montaje.

Aluminio



Arce
SVAL2

GT(cm)	TT(IN)	AL(cm)	FH(IN)	PN(kg)	NW(LB)	REF.(CODE)	PTOS (PT)
0,3	0,1	71,0	28,0	15,7	34,7	30200418	760



Mesa rectangular modelo Viken.
Estructura de aluminio color Antracita y top en lamas de aluminio color Antracita.
Requiere montaje.

Aluminio



Antracita
SVAL4

GT(cm)	TT(IN)	AL(cm)	FH(IN)	PN(kg)	NW(LB)	REF.(CODE)	PTOS (PT)
0,3	0,1	71,0	28,0	15,7	34,7	30200419	760

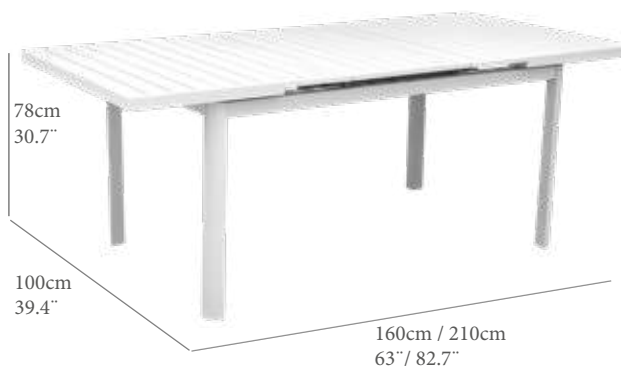

Mesa rectangular extensible modelo Vken.
Estructura de aluminio color blanco y top en lamas de aluminio color blanco.
Requiere montaje.

Aluminio

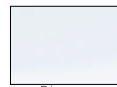

Blanco
SVAL1

GT(cm)	TT(IN)	AL(cm)	FH(IN)	PN(kg)	NW(LB)	REF.(CODE)	PTOS (PT)
0,3	0,1	70,5	27,8	27,8	61,4	30200414	1168



Mesa rectangular extensible modelo Vken.
Estructura de aluminio color Arce y top en lamas de aluminio color Arce.
Requiere montaje.

Aluminio



Arce
SVAL2

GT(cm)	TT(IN)	AL(cm)	FH(IN)	PN(kg)	NW(LB)	REF.(CODE)	PTOS (PT)
0,3	0,1	70,5	27,8	27,8	61,4	30200415	1168



Mesa rectangular extensible modelo Vken.
Estructura de aluminio color Antracita y top en lamas de aluminio color Antracita.
Requiere montaje.

Aluminio



Antracita
SVAL4

GT(cm)	TT(IN)	AL(cm)	FH(IN)	PN(kg)	NW(LB)	REF.(CODE)	PTOS (PT)
0,3	0,1	70,5	27,8	27,8	61,4	30200416	1168

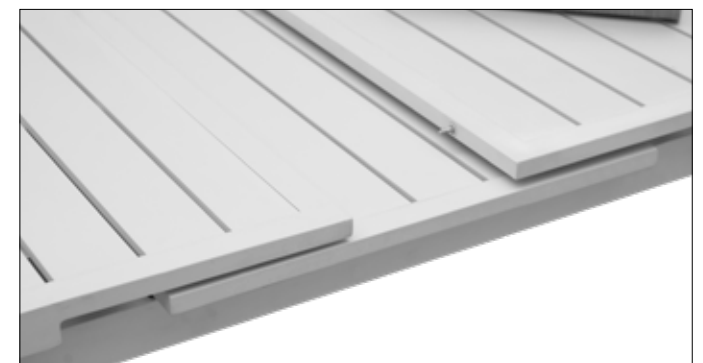



Sofa 1 plaza modelo Viken. Estructura de aluminio color blanco y cuerda elastica en Olefina color gris claro. Cojín de asiento y respaldo (10cm) color gris claro.

Aluminio		Cuerda		Textil	
	Blanco SVAL1		Gris claro SVCR1		Gris claro SVTL5
AA(cm)	SH(IN)	AB(cm)	AH(IN)	AE(cm)	FH(IN)
40,0	15,7	66,0	25,9	72	28,3
PN(kg)	NW(LB)	REF.(CODE)		PTOS (PT)	
11,7	25,8	30200670		782	



Sofa 3 plazas modelo Viken. Estructura de aluminio color blanco y cuerda elastica en Olefina color gris claro. Cojín de asiento y respaldo (10cm) color gris claro.

Aluminio		Cuerda		Textil	
	Blanco SVAL1		Gris claro SVCR1		Gris claro SVTL5
AA(cm)	SH(IN)	AB(cm)	AH(IN)	AE(cm)	FH(IN)
40,0	15,7	66,0	25,9	72	28,3
PN(kg)	NW(LB)	REF.(CODE)		PTOS (PT)	
29,5	65,0	30200671		1744	



Sofa 1 plaza modelo Viken. Estructura de aluminio color blanco y cuerda elastica en Olefina color Taupe. Cojín de asiento y respaldo (10cm) color Taupe.

Aluminio		Cuerda		Textil	
	Blanco SVAL1		Taupe SVCR2		Taupe SVTL7
AA(cm)	SH(IN)	AB(cm)	AH(IN)	AE(cm)	FH(IN)
40,0	15,7	66,0	25,9	72	28,3
PN(kg)	NW(LB)	REF.(CODE)		PTOS (PT)	
11,7	25,8	30200672		782	



Sofa 3 plazas modelo Viken. Estructura de aluminio color blanco y cuerda elastica en Olefina color Taupe. Cojín de asiento y respaldo (10cm) color Taupe.

Aluminio		Cuerda		Textil	
	Blanco SVAL1		Taupe SVCR2		Taupe SVTL7
AA(cm)	SH(IN)	AB(cm)	AH(IN)	AE(cm)	FH(IN)
40,0	15,7	66,0	25,9	72	28,3
PN(kg)	NW(LB)	REF.(CODE)		PTOS (PT)	
29,5	65,0	30200673		1744	



Sofa 1 plaza modelo Viken. Estructura de aluminio color antracita y cuerda elastica en Olefina color antracita. Cojín de asiento y respaldo (10cm) color gris Tempo.

Aluminio		Cuerda		Textil	
	Antracita SVAL4		Antracita SVCR3		Gris Tempo SVTX9
AA(cm)	SH(IN)	AB(cm)	AH(IN)	AE(cm)	FH(IN)
40,0	15,7	66,0	25,9	72	28,3
PN(kg)	NW(LB)	REF.(CODE)		PTOS (PT)	
11,7	25,8	30200674		782	



Sofa 3 plazas modelo Viken. Estructura de aluminio color antracita y cuerda elastica en Olefina color antracita. Cojín de asiento y respaldo (10cm) color gris Tempo.

Aluminio		Cuerda		Textil	
	Antracita SVAL4		Antracita SVCR3		Gris Tempo SVTX9
AA(cm)	SH(IN)	AB(cm)	AH(IN)	AE(cm)	FH(IN)
40,0	15,7	66,0	25,9	72	28,3
PN(kg)	NW(LB)	REF.(CODE)		PTOS (PT)	
29,5	65,0	30200675		1744	

Mesa auxiliar modelo Viken. Estructura de aluminio color blanco y top de aluminio color blanco. Requiere montaje.

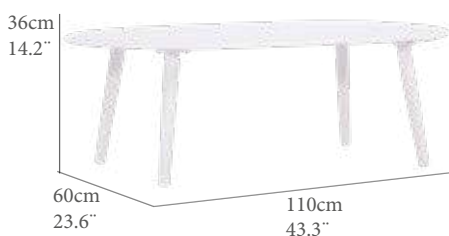

Aluminio	
	Blanco SVAL1
GT(cm)	TT(IN)
0,5	0,2
AL(cm)	FH(IN)
35,0	13,8
PN(kg)	NW(LB)
9,0	17,6
REF.(CODE)	
30200676	
PTOS (PT)	
372	

Mesa auxiliar modelo Viken. Estructura de aluminio color antracita y top de aluminio color antracita. Requiere montaje.



Aluminio	
	Antracita SVAL4
GT(cm)	TT(IN)
0,5	0,2
AL(cm)	FH(IN)
35,0	13,8
PN(kg)	NW(LB)
9,0	17,6
REF.(CODE)	
30200677	
PTOS (PT)	
372	



Taburete alto modelo Viken. Estructura de aluminio color blanco y cuerda elastica en Olefina color gris claro. Cojin de asiento (5cm) color gris claro.

Aluminio	Cuerda	Textil			
Blanco SVAL1	Gris claro SVCRI	Gris claro SVTL5			
AA(cm)	SH(IN)	AB(cm)	AH(IN)	AE(cm)	FH(IN)
40,0	15,7	66,0	25,9	72	28,3
PN(kg)	NW(LB)	REF.(CODE)	PTOS (PT)		
11,7	25,8	30200660	358		



Taburete alto modelo Viken. Estructura de aluminio color blanco y cuerda elastica en Olefina color Taupe. Cojin de asiento (5cm) color Taupe.

Aluminio	Cuerda	Textil			
Blanco SVAL1	taupe SVCRI2	taupe SVTL7			
AA(cm)	SH(IN)	AB(cm)	AH(IN)	AE(cm)	FH(IN)
40,0	15,7	66,0	25,9	72	28,3
PN(kg)	NW(LB)	REF.(CODE)	PTOS (PT)		
11,7	25,8	30200661	358		



Taburete alto modelo Viken. Estructura de aluminio color antracita y cuerda elastica en Olefina color antracita. Cojin de asiento (5cm) color gris Tempo.

Aluminio	Cuerda	Textil			
Antracita SVAL4	Antracita SVCRI3	Gris tempo SVTX9			
AA(cm)	SH(IN)	AB(cm)	AH(IN)	AE(cm)	FH(IN)
40,0	15,7	66,0	25,9	72	28,3
PN(kg)	NW(LB)	REF.(CODE)	PTOS (PT)		
11,7	25,8	30200662	358		

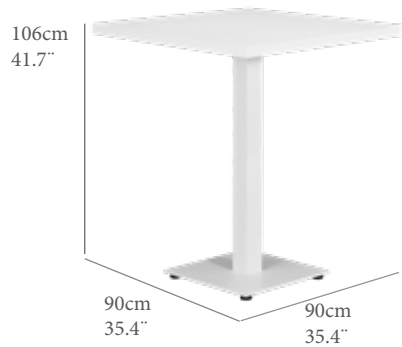

Mesa bar cuadrada blanca. Estructura de aluminio color blanco y top de aluminio color blanco . Requiere montaje.

Aluminio					
Blanco SVAL1					
GT(cm)	TT(IN)	AL(cm)	FH(IN)		
4,0	1,6	102	40,2		
PN(kg)	NW(LB)	REF.(CODE)	PTOS (PT)		
34,3	75,6	30200691	596		

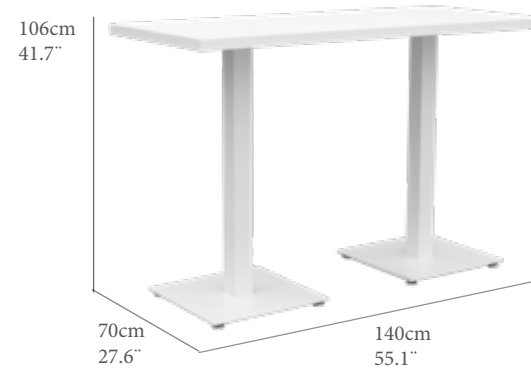

Mesa bar rectangular blanca. Estructura de aluminio color blanco y top de aluminio color blanco . Requiere montaje.

Aluminio					
Blanco SVAL1					
GT(cm)	TT(IN)	AL(cm)	FH(IN)		
4,0	1,6	102	40,2		
PN(kg)	NW(LB)	REF.(CODE)	PTOS (PT)		
49,8	109,8	30200693	676		



Mesa bar cuadrada blanca.. Estructura de aluminio color blanco y top de aluminio color blanco . Requiere montaje.

Aluminio					
Antracita SVAL4					
GT(cm)	TT(IN)	AL(cm)	FH(IN)		
4,0	1,6	102	40,2		
PN(kg)	NW(LB)	REF.(CODE)	PTOS (PT)		
34,3	75,6	30200695	596		



Mesa bar rectangular blanca. Estructura de aluminio color blanco y top de aluminio color blanco . Requiere montaje.

Aluminio					
Antracita SVAL4					
GT(cm)	TT(IN)	AL(cm)	FH(IN)		
4,0	1,6	102	40,2		
PN(kg)	NW(LB)	REF.(CODE)	PTOS (PT)		
49,8	109,8	30200697	676		



Daybed modelo Viken. Estructura de aluminio color blanco y cuerda elastica en Olefina color gris claro. Colchon de 10cm color gris claro. Respaldo regulable en altura.

Aluminio	Cuerda	Textil
		
Blanco SVAL1	Gris claro SVCR1	Gris claro SVTL5

AA(cm)	SH(IN)	AR(cm)	BH(IN)	AE(cm)	FH(IN)
39,0	15.3	40/82	15.7/32.2	54	21.2
PN(kg)	NW(LB)	REF.(CODE)	PTOS (PT)		
49	108	30200665	2700		



Daybed modelo Viken. Estructura de aluminio color blanco y cuerda elastica en Olefina color Taupe. Colchon de 10cm color Taupe. Respaldo regulable en altura.

Aluminio	Cuerda	Textil
		
Blanco SVAL1	taupe SVCR2	taupe SVTL7

AA(cm)	SH(IN)	AR(cm)	BH(IN)	AE(cm)	FH(IN)
39,0	15.3	40/82	15.7/32.2	54	21.2
PN(kg)	NW(LB)	REF.(CODE)	PTOS (PT)		
49	108	30200666	2700		



Daybed modelo Viken. Estructura de aluminio color antracita y cuerda elastica en Olefina color antracita. Colchon de 10cm color gris Tempo. Respaldo regulable en altura.

Aluminio	Cuerda	Textil
		
Antracita SVAL4	Antracita SVCR3	Gris Tempo SVTX9

AA(cm)	SH(IN)	AR(cm)	BH(IN)	AE(cm)	FH(IN)
39,0	15.3	40/82	15.7/32.2	54	21.2
PN(kg)	NW(LB)	REF.(CODE)	PTOS (PT)		
49	108	30200667	2700		



Silla de comedor Vega. Estructura de aluminio color blanco y cuerda elastica en Olefina color gris claro. Cojín de asiento (5cm) color gris claro.

Aluminio		Cuerda		Textil	
	Blanco SVAL1		Gris claro SVCR9		Gris medio SVTL27
AA(cm)	SH(IN)	AB(cm)	AH(IN)	AE(cm)	FH(IN)
44.5	17.5	67	26.3	83	32.7
PN(kg)	NW(LB)	REF.(CODE)		PTOS (PT)	
4.4	9,7	30200657		168	



Silla de comedor Vega. Estructura de aluminio color taupe y cuerda elastica en Olefina color Taupe. Cojín de asiento (5cm) color Taupe.

Aluminio		Cuerda		Textil	
	taupe SVAL3		taupe SVCR8		taupe SVTL26
AA(cm)	SH(IN)	AB(cm)	AH(IN)	AE(cm)	FH(IN)
44.5	17.5	67	26.3	83	32.7
PN(kg)	NW(LB)	REF.(CODE)		PTOS (PT)	
4.4	9,7	30200658		168	



Silla de comedor Vega. Estructura de aluminio color antracita y cuerda elastica en Olefina color antracita. Cojín de asiento (5cm) color gris Tempo.

Aluminio		Cuerda		Textil	
	Antracita SVAL4		Antracita SVCR7		Gris tempo SVTX9
AA(cm)	SH(IN)	AB(cm)	AH(IN)	AE(cm)	FH(IN)
44.5	17.5	67	26.3	83	32.7
PN(kg)	NW(LB)	REF.(CODE)		PTOS (PT)	
4.4	9,7	30200659		168	



Sofá modelo Atra. Estructura de aluminio en color blanco. Recubrimiento en textil acrílico de alta calidad color gris acero. Cojinería auxiliar en gris medio y gris claro. Mesa en Aluminio efecto inox y blanco. Alta calidad y resistencia a la intemperie.



Aluminio	Textil	Cojín	Cojín
Blanco SVAL1	Gris acero SVTL28	Gris amatista SVTL29	Gris flurotita SVTL30

AA(CM)	SH(IN)	AB(CM)	AH(IN)	AE(CM)	FH(IN)
38,0	15,0	60,0	23,6	75,0	29,5
PN(KG)	NW(LB)	REF.(CODE)	PTOS (PT)		
84,1	185,4	30200611	4440		

GT(CM)	TT(IN)	AL(CM)	FH(IN)
0,3	0,1	11,0	4,3
PN(KG)	NW(LB)		
13,7	30,2		





Sillón de comedor modelo Aioros. Estructura en aluminio color blanco y cojín de asiento (6cm) y respaldo (10cm) color gris Jaspeado. Revestimiento el cuerda trenzada de alta calidad.

Aluminio	Textil	Cuerda	Auxiliar		
Blanco SVAL1	Gris jaspeado SVTL23	Gris acero SVCR6	Gris profundo SVTL24		
AA(cm)	SH(IN)	AB(cm)	AH(IN)	AE(cm)	FH(IN)
43,0	16,9	68,0	26,8	68,0	26,8
PN(kg)	NW(LB)	REF.(CODE)	PTOS (PT)		
8,5	18,7	30200602	402		



Sofá de 1 plaza modelo Aioros. Estructura en aluminio color blanco y cojín de asiento (12cm) y respaldo (20cm) gris Jaspeado. Cuerda trenzada de alta calidad. Cojín auxiliar incluido.

Aluminio	Textil	Cuerda	Auxiliar		
Blanco SVAL1	Gris jaspeado SVTL23	Gris acero SVCR6	Gris profundo SVTL24		
AA(cm)	SH(IN)	AB(cm)	AH(IN)	AE(cm)	FH(IN)
40,0	15,7	64,0	25,2	68,0	26,8
PN(kg)	NW(LB)	REF.(CODE)	PTOS (PT)		
14,0	30,9	30200604	712		



Sofá de 2 plazas modelo Aioros. Estructura en aluminio color blanco y cojín de asiento (12cm) y respaldo (20cm) gris Jaspeado. Cuerda trenzada de alta calidad. Cojín auxiliar incluido.

Aluminio	Textil	Cuerda	Auxiliar		
Blanco SVAL1	Gris jaspeado SVTL23	Gris acero SVCR6	Gris profundo SVTL24		
AA(cm)	SH(IN)	AB(cm)	AH(IN)	AE(cm)	FH(IN)
40,0	15,7	64,0	25,2	68,0	26,8
PN(kg)	NW(LB)	REF.(CODE)	PTOS (PT)		
22,0	48,5	30200605	1062		



Sofá de 3 plazas modelo Aioros. Estructura en aluminio color blanco y cojín de asiento (12cm) y respaldo (20cm) gris Jaspeado. Cuerda trenzada de alta calidad. Cojín auxiliar incluido.

Aluminio	Textil	Cuerda	Auxiliar		
Blanco SVAL1	Gris jaspeado SVTL23	Gris acero SVCR6	Gris profundo SVTL24		
AA(cm)	SH(IN)	AB(cm)	AH(IN)	AE(cm)	FH(IN)
40,0	15,7	64,0	25,2	68,0	26,8
PN(kg)	NW(LB)	REF.(CODE)	PTOS (PT)		
28,1	61,9	30200606	1390		



Mesa Auxiliar Modelo Aioros. Estructura en aluminio blanco. Encimera en cristal cerámico de 8mm de grosor, efecto Light Grey.

Aluminio	Cristal		
Blanco SVAL1	Cerámico SVCT12		
GT(cm)	TT(IN)	AL(cm)	FH(IN)
0,8	0,3	34,0	13,4
PN(kg)	NW(LB)	REF.(CODE)	PTOS (PT)
11,2	24,7	30200607	572



Mesa de comedor modelo Aioros. Estructura de aluminio blanco y encimera cristal cerámico de 8mm. Requiere montaje.

Aluminio	Cristal		
Blanco SVAL1	Cerámico SVCT13		
GT(cm)	TT(IN)	AL(cm)	FH(IN)
0,8	0,3	69,0	27,2
PN(kg)	NW(LB)	REF.(CODE)	PTOS (PT)
55,7	122,8	30200603	1048



Mesa Auxiliar Modelo Aioros. Estructura en aluminio blanco. Top en aluminio de 8mm de grosor.

Aluminio			
Blanco SVAL1			
GT(cm)	TT(IN)	AL(cm)	FH(IN)
0,3	0,1	47	19,3
PN(kg)	NW(LB)	REF.(CODE)	PTOS (PT)
11,2	24,7	30200608	192



Sofá 1 plaza modelo Deneb. Estructura de Aluminio color Antracita. Trenzado en cuerda sintética 40x1.5mm color Antracita. Cojinería asiento 29cm (Respaldo 12cm) color gris medio. Alta resistencia a la intemperie.



AA(cm)	SH(IN)	AB(cm)	AH(IN)	AE(cm)	FH(IN)
40,0	15,7	67,0	26,4	67,0	26,4
PN(kg)	NW(LB)	REF.(CODE)	PTOS (PT)		
22,0	48,5	30200638	1162		



Sofá giratorio modelo Deneb. Estructura de Aluminio color Antracita. Trenzado en cuerda sintética 40x1.5mm color Antracita. Cojinería asiento 29cm (Respaldo 12cm) color gris medio. Alta resistencia a la intemperie.



AA(cm)	SH(IN)	AB(cm)	AH(IN)	AE(cm)	FH(IN)
40,0	15,7	67,0	26,4	67,0	26,4
PN(kg)	NW(LB)	REF.(CODE)	PTOS (PT)		
26,7	58,8	30200650	1502		



Lateral brazo derecho modelo Deneb. Estructura de Aluminio color Antracita. Trenzado en cuerda sintética 40x1.5mm color Antracita. Cojinería asiento 29cm (Respaldo 12cm) color gris medio. Alta resistencia a la intemperie.



AA(cm)	SH(IN)	AB(cm)	AH(IN)	AE(cm)	FH(IN)
40,0	15,7	67,0	26,4	67,0	26,4
PN(kg)	NW(LB)	REF.(CODE)	PTOS (PT)		
21,0	46,3	30200640	1231		



Lateral brazo izquierdo modelo Deneb. Estructura de Aluminio color Antracita. Trenzado en cuerda sintética 40x1.5mm color Antracita. Cojinería asiento 29cm (Respaldo 12cm) color gris medio. Alta resistencia a la intemperie.



AA(cm)	SH(IN)	AB(cm)	AH(IN)	AE(cm)	FH(IN)
40,0	15,7	67,0	26,4	67,0	26,4
PN(kg)	NW(LB)	REF.(CODE)	PTOS (PT)		
21,0	46,3	30200639	1231		



Modulo de ampliación modelo Deneb. Estructura de Aluminio color Antracita. Trenzado en cuerda sintética 40x1.5mm color Antracita. Cojinería asiento 29cm (Respaldo 12cm) color gris medio. Alta resistencia a la intemperie.



AA(cm)	SH(IN)	AB(cm)	AH(IN)	AE(cm)	FH(IN)
40,0	15,7	67,0	26,4	67,0	26,4
PN(kg)	NW(LB)	REF.(CODE)	PTOS (PT)		
14,2	31,3	30200641	707		



Mesa auxiliar modelo Deneb. Estructura de Aluminio color Antracita. Trenzado en cuerda sintética 40x1.5mm color Antracita. Top en cristal cerámico 5mm gris. Alta resistencia a la intemperie.



GT(cm)	TT(IN)	AL(cm)	FH(IN)
0,5	0,2	38,0	15,0
PN(kg)	NW(LB)	REF.(CODE)	PTOS (PT)
22,5	49,6	30200637	526



Puff reposapiés modelo Deneb. Estructura de Aluminio color Antracita. Trenzado en cuerda sintética 40x1.5mm color Antracita. Cojinería asiento 29cm color gris medio. Alta resistencia a la intemperie.



AA(cm)	SH(IN)	AB(cm)	AH(IN)	AE(cm)	FH(IN)
40,0	15,7			40,0	15,7
PN(kg)	NW(LB)	REF.(CODE)	PTOS (PT)		
11,5	25,4	30200642	672		



Reposapiés doble modelo Deneb. Estructura de Aluminio color Antracita. Trenzado en cuerda sintética 40x1.5mm color Antracita. Cojinería asiento 29cm color gris medio. Alta resistencia a la intemperie.



AA(cm)	SH(IN)	AB(cm)	AH(IN)	AE(cm)	FH(IN)
40,0	15,7			40,0	15,7
PN(kg)	NW(LB)	REF.(CODE)	PTOS (PT)		
8,8	19,4	30200655	510		



Sillón de comedor Deneb. Estructura de Aluminio color Antracita. Trenzado en cuerda sintética 40x1.5mm color Antracita. Cojinería asiento y respaldo 5cm color gris medio. Alta resistencia a la intemperie.



AA(cm)	SH(IN)	AB(cm)	AH(IN)	AE(cm)	FH(IN)
42.0	16.5	61	24	80	31.5
PN(kg)	NW(LB)	REF.(CODE)		PTOS (PT)	
6.4	14.1	30200651		400	



Mesa de comedor modelo Deneb. Estructura de Aluminio color Antracita. top en cristal cerámico 8mm gris. Alta resistencia a la intemperie.



GT(cm)	TT(IN)	AL(cm)	FH(IN)	
0,8	0,3	69,0	27,1	
PN(kg)	NW(LB)	REF.(CODE)		PTOS (PT)
26.0	10.2	30200652		592



Mesa de comedor modelo Deneb. Estructura de Aluminio color Antracita. top en cristal cerámico 8mm gris. Alta resistencia a la intemperie.

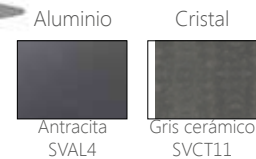

GT(cm)	TT(IN)	AL(cm)	FH(IN)	
0,8	0,3	69,0	27,1	
PN(kg)	NW(LB)	REF.(CODE)		PTOS (PT)
54.0	119.2	30200653		968



Tumbona modelo Deneb. Estructura de Aluminio color Antracita. Trenzado en cuerda sintética 40x1.5mm color Antracita. Cojinería asiento 29cm color gris medio. Alta resistencia a la intemperie.



AA(cm)	SH(IN)	AR(cm)	BH(IN)	AB(cm)	AA(IN)
40,0	15,7	40/102	15,7/40,1		
PN(kg)	NW(LB)	REF.(CODE)		PTOS (PT)	
31,0	68,3	30200643		1448	



Mesa de comedor modelo Deneb. Estructura de Aluminio color Antracita. top en cristal cerámico 8mm gris. Alta resistencia a la intemperie.



GT(cm)	TT(IN)	AL(cm)	FH(IN)	
0,8	0,3	65,0	27,1	
PN(kg)	NW(LB)	REF.(CODE)		PTOS (PT)
64.23	141.7	30200654		1760



Modulo curvo brazo derecho Deneb. Estructura de Aluminio color Antracita. Trenzado en cuerda sintética 40x15mm color Antracita. Cojineria asiento 29cm (Respaldo 12cm) color gris medio. Alta resistencia a la intemperie.

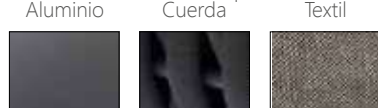

AA(cm)	SH(IN)	AB(cm)	AH(IN)	AE(cm)	FH(IN)
40,0	15,7	67,0	26,4	67,0	26,4
PN(kg)	NW(LB)	REF.(CODE)	PTOS (PT)		
26,5	58,4	30200646	1478		



Modulo curvo brazo izquierdo Deneb. Estructura de Aluminio color Antracita. Trenzado en cuerda sintética 40x15mm color Antracita. Cojineria asiento 29cm (Respaldo 12cm) color gris medio. Alta resistencia a la intemperie.

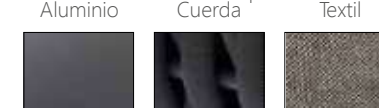

AA(cm)	SH(IN)	AB(cm)	AH(IN)	AE(cm)	FH(IN)
40,0	15,7	67,0	26,4	67,0	26,4
PN(kg)	NW(LB)	REF.(CODE)	PTOS (PT)		
26,5	58,4	30200645	1478		



Modulo curvo Deneb. Estructura de Aluminio color Antracita. Trenzado en cuerda sintética 40x15mm color Antracita. Cojineria asiento 29cm (Respaldo 12cm) color gris medio. Alta resistencia a la intemperie.



AA(cm)	SH(IN)	AB(cm)	AH(IN)	AE(cm)	FH(IN)
40,0	15,7	67,0	26,4	67,0	26,4
PN(kg)	NW(LB)	REF.(CODE)	PTOS (PT)		
29,0	63,9	30200647	2732		

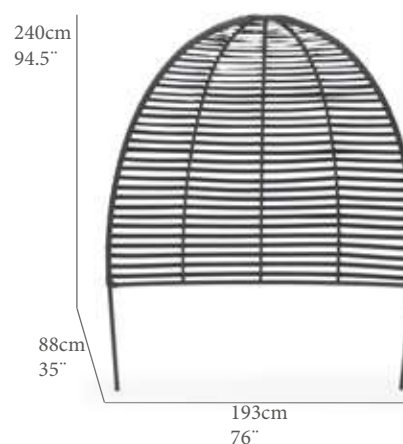

Cubierta solar para modulo curvo Deneb. Estructura de Aluminio color Antracita. Trenzado en cuerda sintética 40x15mm color Antracita. Alta resistencia a la intemperie.



PN(kg)	NW(LB)	REF.(CODE)	PTOS (PT)	
14,5	32	30200648	1102	



Ø90cm
Ø35.5"

Mesa redonda auxiliar Deneb. Estructura de Aluminio color Antracita. Trenzado en cuerda sintética 40x15mm color Antracita. Top en HPL 10mm gris. Alta resistencia a la intemperie.



GT(cm)	TT(IN)	AL(cm)	FH(IN)
1	0,4	65,0	25,6
PN(kg)	NW(LB)	REF.(CODE)	PTOS (PT)
17,1	37,7	30200649	944



Mesa auxiliar modelo Deneb. Estructura de Aluminio color Antracita. Trenzado en cuerda sintética 40x1.5mm color Antracita. Top en cristal cerámico 8mm gris. Alta resistencia a la intemperie.



GT(cm)	TT(IN)	AL(cm)	FH(IN)
0,8	0,3	50,0	19,7
PN(kg)	NW(LB)	REF.(CODE)	PTOS (PT)
17	21,4	30200644	668



Sofá 1 plaza modelo Borgen. Estructura de Aluminio color gris claro. Trenzado en cuerda sintética 6mm color gris claro. Cojinería asiento 15cm (Respaldo 12cm) color gris claro. Alta resistencia a la intemperie.



AA(cm)	SH(IN)	AB(cm)	AH(IN)	AE(cm)	FH(IN)
41,0	16,1	54,0	21,3	75,0	29,5
PN(kg)	NW(LB)	REF.(CODE)	PTOS (PT)		
13,5	29,8	30200630	944		



Sofá 2 plazas modelo Borgen. Estructura de Aluminio color gris claro. Trenzado en cuerda sintética 6mm color gris claro. Cojinería asiento 15cm (Respaldo 12cm) color gris claro. Alta resistencia a la intemperie.



AA(cm)	SH(IN)	AB(cm)	AH(IN)	AE(cm)	FH(IN)
41,0	16,1	54,0	21,3	75,0	29,5
PN(kg)	NW(LB)	REF.(CODE)	PTOS (PT)		
29,0	63,9	30200631	1674		



Reposapiés modelo Borgen. Estructura de Aluminio color gris claro. Trenzado en cuerda sintética 6mm color gris claro. Cojinería asiento 15cm (Respaldo 12cm) color gris claro. Alta resistencia a la intemperie.



AA(cm)	SH(IN)	AB(cm)	AH(IN)	AE(cm)	FH(IN)
41,0	16,1			26,0	10,2
PN(kg)	NW(LB)	REF.(CODE)	PTOS (PT)		
4,1	9,0	30200632	300		



Reposapiés doble modelo Borgen. Estructura de Aluminio color gris claro. Trenzado en cuerda sintética 6mm color gris claro. Cojinería asiento 15cm (Respaldo 12cm) color gris claro. Alta resistencia a la intemperie.



AA(cm)	SH(IN)	AB(cm)	AH(IN)	AE(cm)	FH(IN)
41,0	16,1			26,0	10,2
PN(kg)	NW(LB)	REF.(CODE)	PTOS (PT)		
10,0	22,0	30200635	536		



Mesa auxiliar modelo Borgen. Estructura de Aluminio color gris claro. Top en aluminio laminado 5mm gris. Alta resistencia a la intemperie.



GT(cm)	TT(IN)	AL(cm)	FH(IN)
0,3	0,1	45,0	17,7
PN(kg)	NW(LB)	REF.(CODE)	PTOS (PT)
3,9	8,6	30200633	220



Mesa auxiliar modelo Borgen. Estructura de Aluminio color gris claro. Top en aluminio laminado 5mm gris. Alta resistencia a la intemperie.



GT(cm)	TT(IN)	AL(cm)	FH(IN)
0,3	0,1	40,0	15,7
PN(kg)	NW(LB)	REF.(CODE)	PTOS (PT)
5,0	11,0	30200634	264



Daybed modelo Borgen. Estructura de Aluminio color gris claro. Trenzado en cuerda sintética 6mm color gris claro. Cojinería asiento 15cm (Respaldo 12cm) color gris claro. Alta resistencia a la intemperie.



AA(cm)	SH(IN)	AR(cm)	BH(IN)	AB(cm)	AA(IN)
41,0	16,1	41/81	16,1/31,9	54,0	21,3
PN(kg)	NW(LB)	REF.(CODE)	PTOS (PT)		
38,9	85,8	30200636	2234		



Sillón de comedor modelo Long Island. Estructura en aluminio color Greige y cojinería acrílica (5cm) color gris Jaspeado. Revestimiento el cuerda trenzada de alta calidad.



AA(cm)	SH(IN)	AB(cm)	AH(IN)	AE(cm)	FH(IN)
47,0	18,5	65,0	25,6	87,0	34,3
PN(kg)	NW(LB)	REF.(CODE)	PTOS (PT)		
4,6	10,1	30200754	328		



Taburete alto modelo Long Island. Estructura en aluminio color Greige y cojinería acrílica (5cm) color gris Jaspeado. Revestimiento el cuerda trenzada de alta calidad.



AA(cm)	SH(IN)	AB(cm)	AH(IN)	AE(cm)	FH(IN)
73	28,7			103	40,5
PN(kg)	NW(LB)	REF.(CODE)	PTOS (PT)		
4,9	11,0	30200763	440		



Sofá de 2 plazas modelo Long Island. Estructura en aluminio color Greige, cojín de asiento (10cm) y respaldo (12cm) color gris Jaspeado. Revestimiento en cuerda trenzada alta calidad.



AA(cm)	SH(IN)	AB(cm)	AH(IN)	AE(cm)	FH(IN)
40,0	15,7	62,0	24,4	70,0	27,6
PN(kg)	NW(LB)	REF.(CODE)	PTOS (PT)		
30,0	66,1	30200751	2728		



Sofá de 1 plaza Long Island. Estructura en aluminio color Greige, cojín de asiento (10cm) y respaldo (12cm) color gris Jaspeado. Revestimiento en cuerda trenzada alta calidad.



AA(cm)	SH(IN)	AB(cm)	AH(IN)	AE(cm)	FH(IN)
40,0	15,7	62,0	24,4	70,0	27,6
PN(kg)	NW(LB)	REF.(CODE)	PTOS (PT)		
15,2	33,5	30200750	1370		



Mesa alta modelo Long island. Estructura en aluminio color Greige. Encimera en cristal templado de 8mm color Old marble.



GT(cm)	TT(IN)	AL(cm)	FH(IN)
0,8	0,3	89,0	35,0
PN(kg)	NW(LB)	REF.(CODE)	PTOS (PT)
23,7	52,2	30200764	542



Mesa de comedor modelo Long island. Estructura en aluminio color Greige. Encimera en cristal templado de 8mm color Old marble.



GT(cm)	TT(IN)	AL(cm)	FH(IN)
0,8	0,3	89,0	35,0
PN(kg)	NW(LB)	REF.(CODE)	PTOS (PT)
23,7	52,2	30200765	896



Mesa de comedor modelo Long island. Estructura en aluminio color Greige. Encimera en cristal templado de 8mm color Old marble.

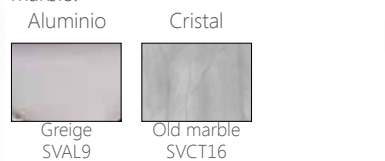

GT(cm)	TT(IN)	AL(cm)	FH(IN)
0,8	0,3	89,0	35,0
PN(kg)	NW(LB)	REF.(CODE)	PTOS (PT)
23,7	52,2	30200766	1018



Mesa de comedor **auto-extensible** modelo Long island. Estructura en aluminio color Greige. Encimera en cristal templado de 8mm color Old marble.



GT(cm)	TT(IN)	AL(cm)	FH(IN)
1,0	0,4	70,0	27,6
PN(kg)	NW(LB)	REF.(CODE)	PTOS (PT)
89,6	197,5	30200755	2618



Sofá 2 pl. brazo derecho Long Island. Estructura en aluminio color Greige, cojín de asiento (10cm) y respaldo (12cm) color gris Jaspeado. Revestimiento en cuerda trenzada alta calidad.



AA(cm)	SH(IN)	AB(cm)	AH(IN)	AE(cm)	FH(IN)
40,0	15,7	62,0	24,4	70,0	27,6
PN(kg)	NW(LB)	REF.(CODE)	PTOS (PT)		
26,7	58,9	30200760	2192		



Sofá 2 pl. brazo izquierdo Long Island. Estructura en aluminio color Greige, cojín de asiento (10cm) y respaldo (12cm) color gris Jaspeado. Revestimiento en cuerda trenzada alta calidad.



AA(cm)	SH(IN)	AB(cm)	AH(IN)	AE(cm)	FH(IN)
40,0	15,7	62,0	24,4	70,0	27,6
PN(kg)	NW(LB)	REF.(CODE)	PTOS (PT)		
26,7	58,9	30200761	2192		



Mesa auxiliar modelo Long Island. Estructura en aluminio color Greige y cristal templado de 8mm terminacion old marble. Revestimiento el cuerda trenzada de alta calidad.



GT(cm)	TT(IN)	AL(cm)	FH(IN)
0,8	0,3	13,0	5,11
PN(kg)	NW(LB)	REF.(CODE)	PTOS (PT)
16,5	21,0	30200762	528



Mesa auxiliar modelo Long Island. Estructura en aluminio color Greige y cristal templado de 8mm terminacion old marble. Revestimiento el cuerda trenzada de alta calidad.



GT(cm)	TT(IN)	AL(cm)	FH(IN)
0,8	0,3	24,0	9,4
PN(kg)	NW(LB)	REF.(CODE)	PTOS (PT)
23,4	51,6	30200749	644



Daybed modelo Long Island. Estructura en aluminio color Greige, cojín de asiento (10cm) y respaldo (12cm) color gris Jaspeado. Revestimiento en cuerda trenzada alta calidad.



AA(cm)	SH(IN)	AR(cm)	BH(IN)	AB(cm)	AA(IN)
40,0	15,7	40/92	15,7/36,2		
PN(kg)	NW(LB)	REF.(CODE)	PTOS (PT)		
35,5	78,3	30200753	1948		



Tumbona modelo Long Island. Estructura en aluminio color Greige, cojín de asiento (10cm) y respaldo (12cm) color gris Jaspeado. Revestimiento en cuerda trenzada alta calidad.



AA(cm)	SH(IN)	AR(cm)	BH(IN)	AB(cm)	AA(IN)
40,0	15,7	40/92	15,7/36,2		
PN(kg)	NW(LB)	REF.(CODE)	PTOS (PT)		
18,6	41,0	30200752	1520		



Reposapiés Long Island. Estructura en aluminio color Greige y cojineria acrílica color gris Jaspeado. Revestimiento el cuerda trenzada de alta calidad.



AA(cm)	SH(IN)	AB(cm)	AH(IN)	AE(cm)	FH(IN)
40,0	15,7			30,0	11,8
PN(kg)	NW(LB)	REF.(CODE)	PTOS (PT)		
5,2	11,5	30200758	290		



Balancín Long Island. Estructura acero/aluminio color Greige, cojín de asiento (10cm) y respaldo (12cm) color gris Jaspeado. Revestimiento en cuerda trenzada alta calidad.



PN(kg)	NW(LB)	REF.(CODE)	PTOS (PT)	
31,5	69,4	30200759	1070	



Silla de comedor modelo Nirea. Teca de primera calidad con herrajes en acero inoxidable. Requiere montaje.

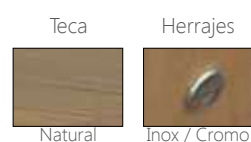

AA(cm)	SH(IN)	AB(cm)	AH(IN)	AE(cm)	FH(IN)
45,0	17,7			84,0	33,1
PN(kg)	NW(LB)	REF.(CODE)	PTOS (PT)		
9,5	20,9	30100172	190		



Sofa de 1 plaza modelo Nirea. Teca de primera calidad con herrajes en acero inoxidable. Cojinería de asiento (14cm) y respaldo(12cm) color blanco. Requiere montaje.



AA(cm)	SH(IN)	AB(cm)	AH(IN)	AE(cm)	FH(IN)
44,0	17,3	54,5	21,5	76,5	30,1
PN(kg)	NW(LB)	REF.(CODE)	PTOS (PT)		
25,5	56,2	30100167	606		



Sofa de 2 plazas modelo Nirea. Teca de primera calidad con herrajes en acero inoxidable. Cojinería de asiento (14cm) y respaldo(12cm) color blanco. Requiere montaje.



AA(cm)	SH(IN)	AB(cm)	AH(IN)	AE(cm)	FH(IN)
44,0	17,3	54,5	21,5	76,5	30,1
PN(kg)	NW(LB)	REF.(CODE)	PTOS (PT)		
39,0	86,0	30100170	1346		



Sofa de 3 plazas modelo Nirea. Teca de primera calidad con herrajes en acero inoxidable. Cojinería de asiento (14cm) y respaldo(12cm) color blanco. Requiere montaje.



AA(cm)	SH(IN)	AB(cm)	AH(IN)	AE(cm)	FH(IN)
44,0	17,3	54,5	21,5	76,5	30,1
PN(kg)	NW(LB)	REF.(CODE)	PTOS (PT)		
53,5	117,9	30100168	2021		



Mesa de comedor cuadrada Nirea. Teca de primera calidad con herrajes en acero inoxidable. Requiere montaje.

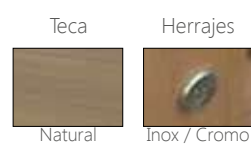

GT(cm)	TT(IN)	AL(cm)	FH(IN)
2,5	1,0	67,5	26,6
PN(kg)	NW(LB)	REF.(CODE)	PTOS (PT)
19,0	41,9	30100173	266



Mesa de comedor rectangular Nirea. Teca de primera calidad con herrajes en acero inoxidable. Requiere montaje.



GT(cm)	TT(IN)	AL(cm)	FH(IN)
2,5	1,0	67,5	26,6
PN(kg)	NW(LB)	REF.(CODE)	PTOS (PT)
37,0	81,6	30100174	506

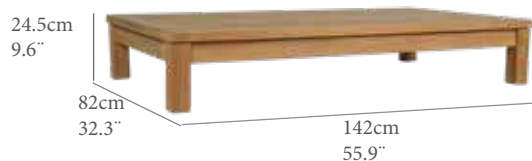

Mesa auxiliar Nirea. Teca de primera calidad con herrajes en acero inoxidable. Requiere montaje.

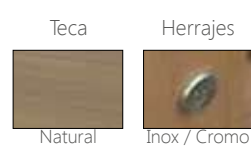

GT(cm)	TT(IN)	AL(cm)	FH(IN)
2,5	1,0	14,5	5,7
PN(kg)	NW(LB)	REF.(CODE)	PTOS (PT)
27,0	59,5	30100169	458



Daybed Nirea. Estructura en teca de primera calidad con herrajes en acero inoxidable. Cojinería waterproof (14cm) color crudo. Cubierta superior y cortinas incluidas. Requiere montaje.



AA(cm)	SH(IN)	AR(cm)	BH(IN)	AB(cm)	AA(IN)
46,0	18,1	33/100	13-39,4		
PN(kg)	NW(LB)	REF.(CODE)	PTOS (PT)		
163,0	359,4	30100175	3832		



Silla de comedor modelo Java. Estructura en teca de primera calidad. Herrajes en acabado inox. Requiere montaje.

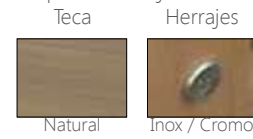

AA(cm)	SH(IN)	AB(cm)	AH(IN)	AE(cm)	FH(IN)
45,0	17,7			99,0	39,0
PN(kg)	NW(LB)	REF.(CODE)	PTOS (PT)		
11,0	24,3	30100138	230		



Silla de comedor con brazos modelo Java. Estructura en teca de primera calidad. Herrajes en acabado inox. Requiere montaje.

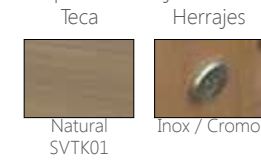

AA(cm)	SH(IN)	AB(cm)	AH(IN)	AE(cm)	FH(IN)
46,0	18,1	66,5	26,2	98,5	38,8
PN(kg)	NW(LB)	REF.(CODE)	PTOS (PT)		
10,0	22,0	30100171	242		



Butaca mecedora modelo Java. Estructura en teca de primera calidad. Herrajes en acabado inox. Requiere montaje.



AA(cm)	SH(IN)	AB(cm)	AH(IN)	AE(cm)	FH(IN)
47,0	18,5	73,0	28,7	112,0	44,1
PN(kg)	NW(LB)	REF.(CODE)	PTOS (PT)		
17,0	37,5	30100139	248		



Butaca 1 plaza modelo Java. Estructura en teca de primera calidad. Herrajes en acabado inox. Requiere montaje.



AA(cm)	SH(IN)	AB(cm)	AH(IN)	AE(cm)	FH(IN)
45,0	17,7	67,5	26,6	92,0	36,2
PN(kg)	NW(LB)	REF.(CODE)	PTOS (PT)		
13,0	28,7	30100093	214z		



Butaca 2 plazas modelo Java. Estructura en teca de primera calidad. Herrajes en acabado inox. Requiere montaje.



AA(cm)	SH(IN)	AB(cm)	AH(IN)	AE(cm)	FH(IN)
45,0	17,7	67,5	26,6	92,0	36,2
PN(kg)	NW(LB)	REF.(CODE)	PTOS (PT)		
21,0	46,3	30100094	324		



Butaca 3 plazas modelo Java. Estructura en teca de primera calidad. Herrajes en acabado inox. Requiere montaje.



AA(cm)	SH(IN)	AB(cm)	AH(IN)	AE(cm)	FH(IN)
45,0	17,7	67,5	26,6	92,0	36,2
PN(kg)	NW(LB)	REF.(CODE)	PTOS (PT)		
26,0	57,3	30100121	360zz		



Silla plegable modelo Edson. Estructura en teca de primera calidad y textilene **Batyline** color negro. Herrajes en acabado inox.

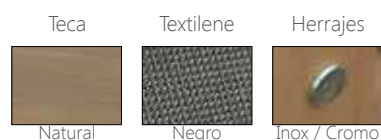

AA(cm)	SH(IN)	AB(cm)	AH(IN)	AE(cm)	FH(IN)
44,0	17,3	65,0	25,6	88,0	34,6
PN(kg)	NW(LB)	REF.(CODE)	PTOS (PT)		
8,0	17,6	30100146	336		



Silla plegable modelo Edson. Estructura en teca de primera calidad y textilene **Batyline** color blanco. Herrajes en acabado inox.

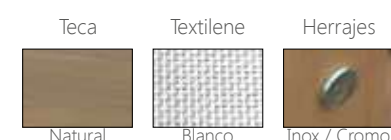

AA(cm)	SH(IN)	AB(cm)	AH(IN)	AE(cm)	FH(IN)
44,0	17,3	65,0	25,6	88,0	34,6
PN(kg)	NW(LB)	REF.(CODE)	PTOS (PT)		
8,0	17,6	30100160	336		



Silla de comedor modelo Edson. Estructura en teca de primera calidad y textilene **Batyline** color negro. Herrajes en acabado inox. Requiere montaje.



AA(cm)	SH(IN)	AB(cm)	AH(IN)	AE(cm)	FH(IN)
44,0	17,3	65,0	25,6	78,0	30,7
PN(kg)	NW(LB)	REF.(CODE)	PTOS (PT)		
8,0	17,6	30100147	342		



Silla de comedor modelo Edson. Estructura en teca de primera calidad y textilene **Batyline** color blanco. Herrajes en acabado inox. Requiere montaje.



AA(cm)	SH(IN)	AB(cm)	AH(IN)	AE(cm)	FH(IN)
44,0	17,3	65,0	25,6	78,0	30,7
PN(kg)	NW(LB)	REF.(CODE)	PTOS (PT)		
8,0	17,6	30100161	342		

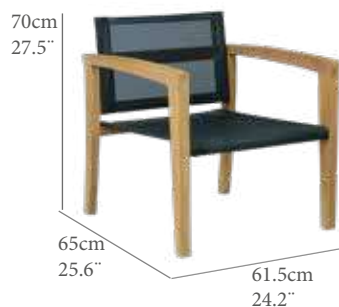

Sillón relax modelo Edson. Estructura en teca de primera calidad y textilene **Batyline** color negro. Herrajes en acabado inox. Requiere montaje.



AA(cm)	SH(IN)	AB(cm)	AH(IN)	AE(cm)	FH(IN)
35,0	13,8	58,0	22,8	69,0	27,2
PN(kg)	NW(LB)	REF.(CODE)	PTOS (PT)		
9,0	19,8	30100148	350		



Sillón relax modelo Edson. Estructura en teca de primera calidad y textilene **Batyline** color blanco. Herrajes en acabado inox. Requiere montaje.

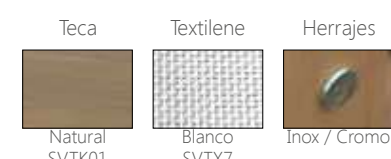

AA(cm)	SH(IN)	AB(cm)	AH(IN)	AE(cm)	FH(IN)
35,0	13,8	58,0	22,8	69,0	27,2
PN(kg)	NW(LB)	REF.(CODE)	PTOS (PT)		
9,0	19,8	30100162	350		



Taburete alto modelo Edson. Estructura en teca de primera calidad y textilene **Batyline** color negro. Herrajes en acabado inox. Requiere montaje.

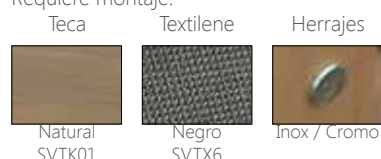

AA(cm)	SH(IN)	AB(cm)	AH(IN)	AE(cm)	FH(IN)
79,0	31,1	101,0	39,8	112,0	44,1
PN(kg)	NW(LB)	REF.(CODE)	PTOS (PT)		
10,5	23,1	30100149	392		



Taburete alto modelo Edson. Estructura en teca de primera calidad y textilene **Batyline** color blanco. Herrajes en acabado inox. Requiere montaje.



AA(cm)	SH(IN)	AB(cm)	AH(IN)	AE(cm)	FH(IN)
79,0	31,1	101,0	39,8	112,0	44,1
PN(kg)	NW(LB)	REF.(CODE)	PTOS (PT)		
10,5	23,1	30100163	392		



Tumbona plegable modelo Edson. Estructura en teca de primera calidad y textilene **Batyline** color negro. Herrajes en acabado inox.

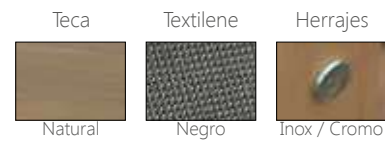

AA(cm)	SH(IN)	AR(cm)	BH(IN)	AB(cm)	AA(IN)
49,0	19,3	82,0	32,3		
PN(kg)	NW(Lb)	REF.(CODE)	PTOS (PT)		
13,0	28,7	30100154	330		



Tumbona plegable modelo Edson. Estructura en teca de primera calidad y textilene **Batyline** color blanco. Herrajes en acabado inox.



AA(cm)	SH(IN)	AR(cm)	BH(IN)	AB(cm)	AA(IN)
49,0	19,3	82,0	32,3		
PN(kg)	NW(Lb)	REF.(CODE)	PTOS (PT)		
13,0	28,7	30100164	330		



Tumbona Edson. Estructura en teca de primera calidad y textilene **Batyline** color negro. Respaldo regulable con herrajes en acabado inox. Requiere montaje.

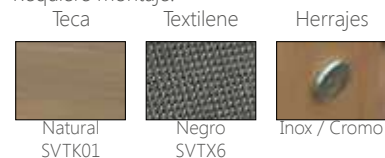

AA(cm)	SH(IN)	AR(cm)	BH(IN)	AB(cm)	AA(IN)
31,0	12,2	31/91	12,2/35,8		
PN(kg)	NW(Lb)	REF.(CODE)	PTOS (PT)		
27,5	60,6	30100166	680		



Tumbona Edson. Estructura en teca de primera calidad y textilene **Batyline** color blanco. Respaldo regulable con herrajes en acabado inox. Requiere montaje.



AA(cm)	SH(IN)	AR(cm)	BH(IN)	AB(cm)	AA(IN)
31,0	12,2	31/91	12,2/35,8		
PN(kg)	NW(Lb)	REF.(CODE)	PTOS (PT)		
27,5	60,6	30100165	680		



Mesa auxiliar redonda modelo Edson. Teca de primera calidad con herrajes en acero inoxidable. Requiere montaje.



GT(cm)	TT(IN)	AL(cm)	FH(IN)
2,5	1,0	44,0	17,3
PN(kg)	NW(Lb)	REF.(CODE)	PTOS (PT)
18,0	39,7	30100200	418



Mesa de comedor redonda modelo Edson. Teca de primera calidad con herrajes en acero inoxidable. Requiere montaje.



GT(cm)	TT(IN)	AL(cm)	FH(IN)
2,5	1,0	68,0	26,8
PN(kg)	NW(Lb)	REF.(CODE)	PTOS (PT)
19,0	41,9	30100126	440



Mesa bar alta modelo Edson. Teca de primera calidad con herrajes en acero inoxidable. Requiere montaje.

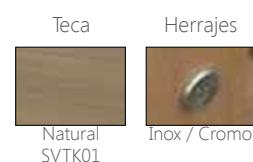

GT(cm)	TT(IN)	AL(cm)	FH(IN)
2,5	1,0	102,0	40,2
PN(kg)	NW(Lb)	REF.(CODE)	PTOS (PT)
28,0	61,7	30100145	920



Silla de comedor modelo Vernom. Teca de primera calidad con herrajes en acero inoxidable. Requiere montaje.



AA(cm)	SH(IN)	AB(cm)	AH(IN)	AE(cm)	FH(IN)
44,0	17,3	66,0	26,0	73,5	28,9
PN(kg)	NW(LB)	REF.(CODE)	PTOS (PT)		
13,0	28,7	30100137	252		



Sofá de una plaza modelo Vernom. Teca de primera calidad con herrajes en acero inoxidable. Cojinería de asiento(14cm) y respaldo(17cm) color crudo. Requiere montaje.



AA(cm)	SH(IN)	AB(cm)	AH(IN)	AE(cm)	FH(IN)
44,0	17,3	64,0	25,2	64,0	25,2
PN(kg)	NW(LB)	REF.(CODE)	PTOS (PT)		
23,2	51,1	30100132	620		



Sofá de dos plazas modelo Vernom. Teca de primera calidad con herrajes en acero inoxidable. Cojinería de asiento(14cm) y respaldo(17cm) color crudo. Requiere montaje.



AA(cm)	SH(IN)	AB(cm)	AH(IN)	AE(cm)	FH(IN)
44,0	17,3	64,0	25,2	64,0	25,2
PN(kg)	NW(LB)	REF.(CODE)	PTOS (PT)		
32,4	71,4	30100133	1250		



Sofá de tres plazas modelo Vernom. Teca de primera calidad con herrajes en acero inoxidable. Cojinería de asiento(14cm) y respaldo(17cm) color crudo. Requiere montaje.



AA(cm)	SH(IN)	AB(cm)	AH(IN)	AE(cm)	FH(IN)
44,0	17,3	64,0	25,2	64,0	25,2
PN(kg)	NW(LB)	REF.(CODE)	PTOS (PT)		
45,6	100,5	30100134	1712		



Modulo de esquina modelo Vernom. Teca de primera calidad con herrajes en acero inoxidable. Cojinería de asiento(14cm) y respaldo(17cm) color crudo. Requiere montaje.



AA(cm)	SH(IN)	AB(cm)	AH(IN)	AE(cm)	FH(IN)
44,0	17,3	64,0	25,2	64,0	25,2
PN(kg)	NW(LB)	REF.(CODE)	PTOS (PT)		
25,2	55,6	30100144	846		



Tramo intermedio modelo Vernom. Teca de primera calidad con herrajes en acero inoxidable. Cojinería de asiento(14cm) y respaldo(17cm) color crudo. Requiere montaje.



AA(cm)	SH(IN)	AB(cm)	AH(IN)	AE(cm)	FH(IN)
44,0	17,3			64,0	25,2
PN(kg)	NW(LB)	REF.(CODE)	PTOS (PT)		
30,4	67,0	30100143	1152		



Lounge brazo izquierdo modelo Vernom. Teca de primera calidad con herrajes en acero inoxidable. Cojinería de asiento(14cm) y respaldo(17cm) color crudo. Requiere montaje.



AA(cm)	SH(IN)	AB(cm)	AH(IN)	AE(cm)	FH(IN)
44,0	17,3	64,0	25,2	64,0	25,2
PN(kg)	NW(LB)	REF.(CODE)	PTOS (PT)		
40,6	89,5	30100141	1240		

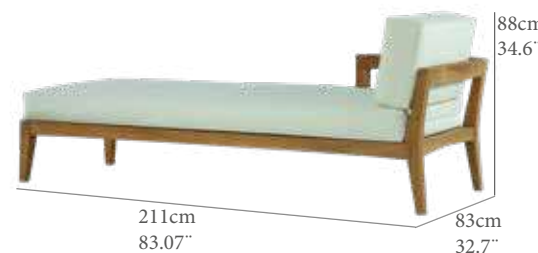

Lounge brazo derecho modelo Vernom. Teca de primera calidad con herrajes en acero inoxidable. Cojinería de asiento(14cm) y respaldo(17cm) color crudo. Requiere montaje.



AA(cm)	SH(IN)	AB(cm)	AH(IN)	AE(cm)	FH(IN)
44,0	17,3	64,0	25,2	64,0	25,2
PN(kg)	NW(LB)	REF.(CODE)	PTOS (PT)		
40,6	89,5	30100142	1240		



Tramo de ampliación modelo Vernom. Teca de primera calidad con herrajes en acero inoxidable. Cojinería de asiento(14cm) y respaldo(17cm) color crudo. Requiere montaje.



AA(cm)	SH(IN)	AB(cm)	AH(IN)	AE(cm)	FH(IN)
44,0	17,3			64,0	25,2
PN(kg)	NW(LB)	REF.(CODE)	PTOS (PT)		
22,2	48,9	30100210	600		



Modulo brazo izquierdo modelo Vernom. Teca de primera calidad con herrajes en acero inoxidable. Cojinería de asiento(14cm) y respaldo(17cm) color crudo. Requiere montaje.



AA(cm)	SH(IN)	AB(cm)	AH(IN)	AE(cm)	FH(IN)
44,0	17,3	64,0	25,2	64,0	25,2
PN(kg)	NW(LB)	REF.(CODE)	PTOS (PT)		
23,2	51,1	30100211	600		



Modulo brazo derecho modelo Vernom. Teca de primera calidad con herrajes en acero inoxidable. Cojinería de asiento(14cm) y respaldo(17cm) color crudo. Requiere montaje.



AA(cm)	SH(IN)	AB(cm)	AH(IN)	AE(cm)	FH(IN)
44,0	17,3	64,0	25,2	64,0	25,2
PN(kg)	NW(LB)	REF.(CODE)	PTOS (PT)		
23,2	51,1	30100212	600		

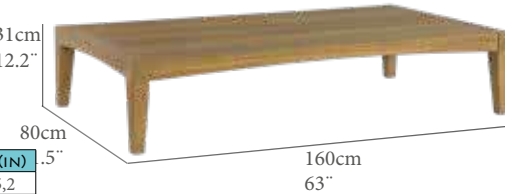

Mesa auxiliar modelo Vernom. Teca de primera calidad con herrajes en acero inoxidable. Cojinería de asiento(14cm) y respaldo(17cm) color crudo. Requiere montaje.

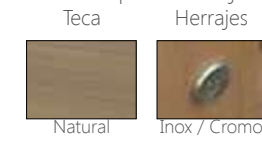

GT(cm)	TT(IN)	AL(cm)	FH(IN)
2,5	1,0	24,0	9,4
PN(kg)	NW(LB)	REF.(CODE)	PTOS (PT)
10,0	22,0	30100135	554



Mesa de comedor extensible modelo Vernom. Teca de primera calidad con herrajes en acero inoxidable. Guías correderas en acero inox. Requiere montaje.



GT(cm)	TT(IN)	AL(cm)	FH(IN)
2,5	1,0	68	26,8
PN(kg)	NW(LB)	REF.(CODE)	PTOS (PT)
85,0	187,4	30100136	1698



Tumbona modelo Vernom. Teca de primera calidad con herrajes en acero inoxidable. Respaldo regulable en 4 posiciones. Cojinería (6cm) opcional. Requiere montaje.



AA(cm)	SH(IN)	AR(cm)	BH(IN)	AB(cm)	AA(IN)
31,0	12,2	31/91	12,2/35,8		
PN(kg)	NW(LB)	REF.(CODE)	PTOS (PT)		
25,0	55,1	30100130	448		

Cojín para tumbona Vernom.

PN(kg)	NW(LB)	REF.(CODE)	PTOS (PT)
4,0	8,8	30400089	252



Composición Vernom 6 piezas:

- 1 Lounge brazo (R). Referencia 30100142
- 1 Tramo intermedio. Referencia 30100143
- 1 Mod. Ampliación. Referencia 30100210
- 1 Mod. Esquinero. Referencia 30100144
- 1 Mod. Brazo (L). Referencia 30100211
- 1 Mesa auxiliar. Referencia 30100135



Composición Vernom 4 piezas:

- 1 mesa auxiliar. Referencia 30100135
- 2 Sofá una plaza. Referencia 30100132
- 1 Sofá tres plazas. Referencia 30100134



Silla de comedor Básica. Estructura en teca de primera calidad. **Cojinería (4cm) opcional.** Plegable.

Teca		Cojinería			
Natural SVTK01		Crudo SVTL14			
AA(CM)	SH(IN)	AB(CM)	AH(IN)	AE(CM)	FH(IN)
45,0	17,7			91,0	35,8
PN(KG)	NW(LB)	REF.(CODE)		PTOS (PT)	
6,5	14,3	30100038		78	

Cojín para silla básica color crudo.

PN(KG)	NW(LB)	REF.(CODE)	PTOS (PT)
1,3	2,9	30400084	130



Silla de comedor Básica con brazos. Estructura en teca de primera calidad. Herrajes terminación latón / Inox. **Cojinería (4cm) opcional.** Plegable.

Teca		Cojinería			
Natural SVTK01		Crudo SVTL14			
AA(CM)	SH(IN)	AB(CM)	AH(IN)	AE(CM)	FH(IN)
45,0	17,7	64,0	25,2	91,0	35,8
PN(KG)	NW(LB)	REF.(CODE)		PTOS (PT)	
8,0	17,6	30100039		126	

Cojín para silla básica color crudo.

PN(KG)	NW(LB)	REF.(CODE)	PTOS (PT)
1,3	2,9	30400084	130



Silla de comedor Sunny. Estructura en teca de primera calidad. **Cojinería (4cm) opcional.** Plegable.

Teca		Cojinería			
Natural SVTK01		Crudo SVTL14			
AA(CM)	SH(IN)	AB(CM)	AH(IN)	AE(CM)	FH(IN)
46,0	18,1			98,0	38,6
PN(KG)	NW(LB)	REF.(CODE)		PTOS (PT)	
8,0	17,6	30100100		104	

Cojín para silla Sunny color crudo.

PN(KG)	NW(LB)	REF.(CODE)	PTOS (PT)
1,4	3,1	30400085	130



Silla de comedor Sunny con brazos. Estructura en teca de primera calidad. Herrajes terminación latón / Inox. **Cojinería (4cm) opcional.** Plegable.

Teca		Cojinería			
Natural SVTK01		Crudo SVTL14			
AA(CM)	SH(IN)	AB(CM)	AH(IN)	AE(CM)	FH(IN)
46,0	18,1	67,0	26,4	98,0	38,6
PN(KG)	NW(LB)	REF.(CODE)		PTOS (PT)	
11,0	24,3	30100101		148	

Cojín para silla Sunny color crudo.

PN(KG)	NW(LB)	REF.(CODE)	PTOS (PT)
1,4	3,1	30400085	130



Sillón reclinable en 4 posiciones modelo Bali. Estructura en teca de primera calidad. Herrajes en Latón / Inox. **Cojinería (6cm) opcional.** Plegable.

Teca		Cojinería			
Natural SVTK01		Crudo SVTL14			
AA(CM)	SH(IN)	AR(CM)	BH(IN)	AB(CM)	AA(IN)
44,0	17,3	80/106	31,5-41,7	69,5	27,4
PN(KG)	NW(LB)	REF.(CODE)		PTOS (PT)	
12,0	26,5	30100079		256	

Cojín para sillón Bali color crudo.

PN(KG)	NW(LB)	REF.(CODE)	PTOS (PT)
2,4	5,3	30400086	184



Sillón reclinable en 4 posiciones modelo Buckingham. Estructura en teca de primera calidad. Herrajes en Latón / Inox. **Cojinería (6cm) opcional.** Plegable.

Teca		Cojinería			
Natural SVTK01		Crudo SVTL14			
AA(CM)	SH(IN)	AR(CM)	BH(IN)	AB(CM)	AA(IN)
46,0	18,1	82,5/110	32,5-43,3	72,0	28,3
PN(KG)	NW(LB)	REF.(CODE)		PTOS (PT)	
13,0	28,7	30100077		256	

Cojín para sillón Buckingham color crudo.

PN(KG)	NW(LB)	REF.(CODE)	PTOS (PT)
2,4	5,3	30400087	184



Sillón modelo Director. Estructura en teca de primera calidad con textilene **Batyline** color negro. Plegable.

Teca		Textilene		Herrajes	
Natural SVTK01		Negro SVTX6		Inox / Cromo	
AA(CM)	SH(IN)	AB(CM)	AH(IN)	AE(CM)	FH(IN)
46,0	18,1	74,5	29,3	89,0	35,0
PN(KG)	NW(LB)	REF.(CODE)		PTOS (PT)	
9,0	19,8	30100120		252	



Sillón modelo Director. Estructura en teca de primera calidad con textilene **Batyline** color blanco. Plegable.

Teca		Textilene		Herrajes	
Natural SVTK01		Blanco SVTX7		Inox / Cromo	
AA(CM)	SH(IN)	AB(CM)	AH(IN)	AE(CM)	FH(IN)
46,0	18,1	74,5	29,3	89,0	35,0
PN(KG)	NW(LB)	REF.(CODE)		PTOS (PT)	
9,0	19,8	30100119		252	



Silla de comedor modelo Java. Estructura en teca de primera calidad. Herrajes en acabado inox. Requiere montaje.



AA(cm)	SH(IN)	AB(cm)	AH(IN)	AE(cm)	FH(IN)
45,0	17,7			99,0	39,0
PN(kg)	NW(Lb)	REF.(CODE)	PTOS (PT)		
11,0	24,3	30100138	230		

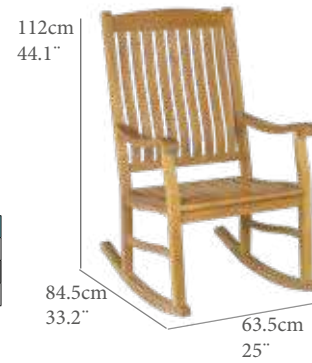

Butaca mecedora modelo Java. Estructura en teca de primera calidad. Herrajes en acabado inox. Requiere montaje.



AA(cm)	SH(IN)	AB(cm)	AH(IN)	AE(cm)	FH(IN)
46,0	18,1	66,5	26,2	98,5	38,8
PN(kg)	NW(Lb)	REF.(CODE)	PTOS (PT)		
10,0	22,0	30100171	242		



Butaca 1 plaza modelo Java. Estructura en teca de primera calidad. Herrajes en acabado inox. Requiere montaje.



AA(cm)	SH(IN)	AB(cm)	AH(IN)	AE(cm)	FH(IN)
47,0	18,5	73,0	28,7	112,0	44,1
PN(kg)	NW(Lb)	REF.(CODE)	PTOS (PT)		
17,0	37,5	30100139	248		



Butaca 2 plazas modelo Java. Estructura en teca de primera calidad. Herrajes en acabado inox. Requiere montaje.



AA(cm)	SH(IN)	AB(cm)	AH(IN)	AE(cm)	FH(IN)
45,0	17,7	67,5	26,6	92,0	36,2
PN(kg)	NW(Lb)	REF.(CODE)	PTOS (PT)		
13,0	28,7	30100093	214z		



Butaca 3 plazas modelo Java. Estructura en teca de primera calidad. Herrajes en acabado inox. Requiere montaje.



AA(cm)	SH(IN)	AB(cm)	AH(IN)	AE(cm)	FH(IN)
45,0	17,7	67,5	26,6	92,0	36,2
PN(kg)	NW(Lb)	REF.(CODE)	PTOS (PT)		
21,0	46,3	30100094	324		



Banco 2 plazas modelo Lombok. Estructura en teca de primera calidad. Herrajes en acabado inox. Requiere montaje.



AA(cm)	SH(IN)	AB(cm)	AH(IN)	AE(cm)	FH(IN)
45,0	17,7	67,5	26,6	92,0	36,2
PN(kg)	NW(Lb)	REF.(CODE)	PTOS (PT)		
26,0	57,3	30100121	360zz		



Banqueta básica 2 plazas. Estructura en teca de primera calidad. Herrajes en acabado inox. Requiere montaje.



AA(cm)	SH(IN)	AB(cm)	AH(IN)	AE(cm)	FH(IN)
45,0	17,7				
PN(kg)	NW(Lb)	REF.(CODE)	PTOS (PT)		
16,0	35,3	30100080	284		



Taburete alto plegable. Estructura en teca de primera calidad. Herrajes en acabado inox. Requiere montaje.



AA(cm)	SH(IN)	AB(cm)	AH(IN)	AE(cm)	FH(IN)
75,0	29,5			115,0	45,3
PN(kg)	NW(Lb)	REF.(CODE)	PTOS (PT)		
8,0	17,6	30100111	188		

Mesa auxiliar redonda modelo Edson. Teca de primera calidad con herrajes en acero inoxidable. Requiere montaje.



GT(cm)	TT(IN)	AL(cm)	FH(IN)
2,5	1,0	37,0	14,6
PN(kg)	NW(LB)	REF.(CODE)	PTOS (PT)
18,0	39,7	30100200	418



Mesa Auxiliar cuadrada plegable. Estructura en teca de primera calidad. Sistema de plegado fácil.



GT(cm)	TT(IN)	AL(cm)	FH(IN)
2,5	1,0	42,5	16,7
PN(kg)	NW(LB)	REF.(CODE)	PTOS (PT)
6,5	14,3	30100115	136

Mesa Auxiliar cuadrada. Estructura en teca de primera calidad. Requiere montaje.



GT(cm)	TT(IN)	AL(cm)	FH(IN)
2,5	1,0	37,0	14,6
PN(kg)	NW(LB)	REF.(CODE)	PTOS (PT)
7,0	15,4	30100064	120



Mesa Auxiliar rectangular. Estructura en teca de primera calidad. Requiere montaje.



GT(cm)	TT(IN)	AL(cm)	FH(IN)
2,5	1,0	37,0	14,6
PN(kg)	NW(LB)	REF.(CODE)	PTOS (PT)
11,0	24,3	30100066	174

Mesa Auxiliar rectangular. Estructura en teca de primera calidad. Requiere montaje.

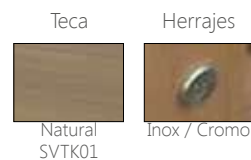

GT(cm)	TT(IN)	AL(cm)	FH(IN)
2,5	1,0	40,0	15,7
PN(kg)	NW(LB)	REF.(CODE)	PTOS (PT)
17,0	37,5	30100065	244

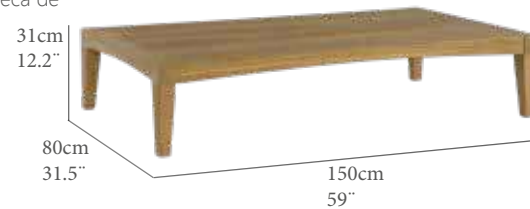

Mesa auxiliar modelo Vernom. Teca de primera calidad con herrajes en acero inoxidable. Requiere montaje.



GT(cm)	TT(IN)	AL(cm)	FH(IN)
2,5	1,0	32,0	12,6
PN(kg)	NW(LB)	REF.(CODE)	PTOS (PT)
10,0	22,0	30100135	554

Mesa auxiliar Nirea. Teca de primera calidad con herrajes en acero inoxidable. Requiere montaje.

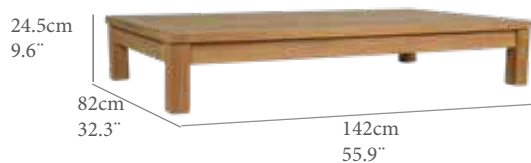

GT(cm)	TT(IN)	AL(cm)	FH(IN)
2,5	1,0	14,5	5,7
PN(kg)	NW(LB)	REF.(CODE)	PTOS (PT)
27,0	59,5	30100169	458

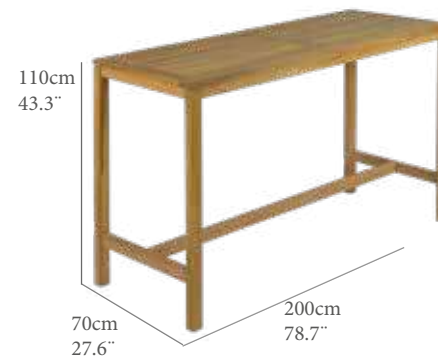

Mesa bar alta modelo Edson. Teca de primera calidad con herrajes en acero inoxidable. Requiere montaje.



GT(cm)	TT(IN)	AL(cm)	FH(IN)
2,5	1,0	102,0	40,2
PN(kg)	NW(LB)	REF.(CODE)	PTOS (PT)
28,0	61,7	30100145	920

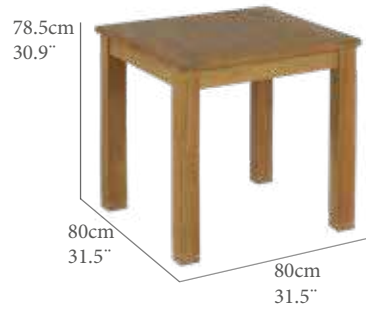

Mesa rustica cuadrada modelo Vernom. Teca de primera calidad con herrajes en acero inoxidable. Requiere montaje.



GT(cm)	TT(IN)	AL(cm)	FH(IN)
2,5	1,0	68,0	26,8
PN(kg)	NW(LB)	REF.(CODE)	PTOS (PT)
25,0	55,1	30100124	490

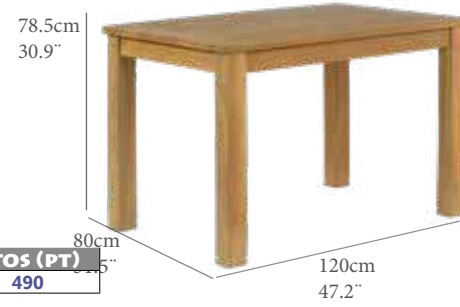

Mesa rustica rectangular modelo Vernom. Teca de primera calidad con herrajes en acero inoxidable. Requiere montaje.



GT(cm)	TT(IN)	AL(cm)	FH(IN)
2,5	1,0	68,0	26,8
PN(kg)	NW(LB)	REF.(CODE)	PTOS (PT)
28,0	61,7	30100123	532



Mesa rustica modelo Vernom. Teca de primera calidad con herrajes en acero inoxidable. Requiere montaje.

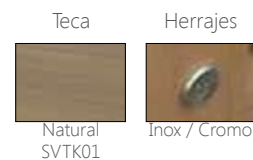

GT(cm)	TT(IN)	AL(cm)	FH(IN)
2,5	1,0	68,0	26,8
PN(kg)	NW(LB)	REF.(CODE)	PTOS (PT)
59,0	130,1	30100114	1050



Mesa rustica modelo Vernom. Teca de primera calidad con herrajes en acero inoxidable. Requiere montaje.



GT(cm)	TT(IN)	AL(cm)	FH(IN)
2,5	1,0	68,0	26,8
PN(kg)	NW(LB)	REF.(CODE)	PTOS (PT)
74,0	163,1	30100102	1332



Mesa de comedor redonda modelo Edson. Teca de primera calidad con herrajes en acero inoxidable. Requiere montaje.



GT(cm)	TT(IN)	AL(cm)	FH(IN)
2,5	1,0	68,0	26,8
PN(kg)	NW(LB)	REF.(CODE)	PTOS (PT)
19,0	41,9	30100126	440



Mesa de comedor **extensible** modelo Vernom. Teca de primera calidad con herrajes en acero inoxidable. Guías correderas en acero inoxidable. Requiere montaje.



GT(cm)	TT(IN)	AL(cm)	FH(IN)
2,5	1,0	68,0	26,8
PN(kg)	NW(LB)	REF.(CODE)	PTOS (PT)
85,0	187,4	30100136	1698



Mesa octogonal **extensible**. Estructura en madera de teca de primera calidad. Sistema de extensión central con apertura simple. Requiere montaje.

Teca Herrajes

Natural SVTK01 Inox / Cromo

GT(cm)	TT(IN)	AL(cm)	FH(IN)
2,5	1,0	61,0	24,0
PN(kg)	NW(LB)	REF.(CODE)	PTOS (PT)
39,0	86,0	30100067	688



Mesa redonda **extensible**. Estructura en madera de teca de primera calidad. Sistema de extensión central con apertura simple. Requiere montaje.

Teca Herrajes

Natural SVTK01 Inox / Cromo

GT(cm)	TT(IN)	AL(cm)	FH(IN)
2,5	1,0	61,0	24,0
PN(kg)	NW(LB)	REF.(CODE)	PTOS (PT)
39,0	86,0	30100074	582



Mesa rectangular **extensible**. Estructura en madera de teca de primera calidad. Sistema de extensión central con apertura simple. Requiere montaje.

Teca Herrajes

Natural SVTK01 Inox / Cromo

GT(cm)	TT(IN)	AL(cm)	FH(IN)
2,5	1,0	61,0	24,0
PN(kg)	NW(LB)	REF.(CODE)	PTOS (PT)
51,0	112,4	30100023	694



Mesa rectangular **extensible**. Estructura en madera de teca de primera calidad. Sistema de extensión central con apertura simple. Requiere montaje.

Teca Herrajes

Natural SVTK01 Inox / Cromo

GT(cm)	TT(IN)	AL(cm)	FH(IN)
2,5	1,0	61,0	24,0
PN(kg)	NW(LB)	REF.(CODE)	PTOS (PT)
56,0	123,5	30100019	896



Mesa rectangular **extensible**. Estructura en madera de teca de primera calidad. Sistema de extensión central con apertura simple. Requiere montaje.

Teca Herrajes

Natural SVTK01 Inox / Cromo

GT(cm)	TT(IN)	AL(cm)	FH(IN)
2,5	1,0	61,0	24,0
PN(kg)	NW(LB)	REF.(CODE)	PTOS (PT)
58,0	127,9	30100070	896



Mesa oval **extensible**. Estructura en madera de teca de primera calidad. Sistema de extensión central con apertura simple. Requiere montaje.

Teca Herrajes

Natural SVTK01 Inox / Cromo

GT(cm)	TT(IN)	AL(cm)	FH(IN)
2,5	1,0	61,0	24,0
PN(kg)	NW(LB)	REF.(CODE)	PTOS (PT)
69,0	152,1	30100068	720



Mesa oval **extensible**. Estructura en madera de teca de primera calidad. Sistema de extensión central con apertura doble. Requiere montaje.

Teca Herrajes

Natural SVTK01 Inox / Cromo

GT(cm)	TT(IN)	AL(cm)	FH(IN)
2,5	1,0	61,0	24,0
PN(kg)	NW(LB)	REF.(CODE)	PTOS (PT)
53,0	116,8	30100069	920



Mesa oval **extensible**. Estructura en madera de teca de primera calidad. Sistema de extensión central con apertura doble. Requiere montaje.

Teca Herrajes

Natural SVTK01 Inox / Cromo

GT(cm)	TT(IN)	AL(cm)	FH(IN)
2,5	1,0	61,0	24,0
PN(kg)	NW(LB)	REF.(CODE)	PTOS (PT)
56,0	123,5	30100091	1226



Conjunto formado por mesa redonda **plegable** Ø60cm + 2 sillas plegables.



AA(cm)	SH(IN)	AL(cm)	TH(IN)	AE(cm)	FH(IN)
45,0	17,7	72,5	28,5	91,0	35,8
PN(kg)	NW(Lb)	REF.(CODE)	PTOS (PT)		
19,0	41,9	30100117	316		



Conjunto formado por mesa redonda **plegable** Ø80cm + 2 sillas plegables.



AA(cm)	SH(IN)	AL(cm)	TH(IN)	AE(cm)	FH(IN)
45,0	17,7	72,5	28,5	91,0	35,8
PN(kg)	NW(Lb)	REF.(CODE)	PTOS (PT)		
25,0	55,1	30100048	326		



Conjunto formado por mesa octogonal **plegable** Ø70cm + 2 sillas plegables.



AA(cm)	SH(IN)	AL(cm)	TH(IN)	AE(cm)	FH(IN)
45,0	17,7	72,5	28,5	91,0	35,8
PN(kg)	NW(Lb)	REF.(CODE)	PTOS (PT)		
25,0	55,1	30100075	326		



Conjunto formado por mesa cuadrada **plegable** 70 x 70cm + 2 sillas plegables.



AA(cm)	SH(IN)	AL(cm)	TH(IN)	AE(cm)	FH(IN)
45,0	17,7	72,5	28,5	91,0	35,8
PN(kg)	NW(Lb)	REF.(CODE)	PTOS (PT)		
25,0	55,1	30100109	326		



Conjunto formado por mesa rectangular **plegable** 120 x 70cm + 4 sillas plegables.



AA(cm)	SH(IN)	AL(cm)	TH(IN)	AE(cm)	FH(IN)
45,0	17,7	72,5	28,5	91,0	35,8
PN(kg)	NW(Lb)	REF.(CODE)	PTOS (PT)		
40,0	88,2	30100110	556		



Conjunto formado por mesa redonda **plegable** Ø100 + 4 sillas plegables.



AA(cm)	SH(IN)	AL(cm)	TH(IN)	AE(cm)	FH(IN)
45,0	17,7	72,5	28,5	91,0	35,8
PN(kg)	NW(Lb)	REF.(CODE)	PTOS (PT)		
40,0	88,2	30100122	530		



Conjunto formado por mesa octogonal **plegable** Ø120 + 4 sillas plegables.



AA(cm)	SH(IN)	AL(cm)	TH(IN)	AE(cm)	FH(IN)
45,0	17,7	72,5	28,5	91,0	35,8
PN(kg)	NW(Lb)	REF.(CODE)	PTOS (PT)		
47,0	103,6	30100047	564		



Conjunto formado por mesa redonda **plegable** Ø120 + 4 sillas plegables.



AA(cm)	SH(IN)	AL(cm)	TH(IN)	AE(cm)	FH(IN)
45,0	17,7	72,5	28,5	91,0	35,8
PN(kg)	NW(Lb)	REF.(CODE)	PTOS (PT)		
47,0	103,6	30100116	564		



Mesa redonda plegable. Teca de primera calidad terminación natural. **Sistema de plegado fácil.**



GT(cm)	TT(IN)	AL(cm)	FH(IN)
2,5	1,0	72,5	28,5
PN(kg)	NW(LB)	REF.(CODE)	PTOS (PT)
6,0	13,2	30100073	160



Mesa redonda plegable. Teca de primera calidad terminación natural. **Sistema de plegado fácil.**



GT(cm)	TT(IN)	AL(cm)	FH(IN)
2,5	1,0	72,5	28,5
PN(kg)	NW(LB)	REF.(CODE)	PTOS (PT)
12,0	26,5	30100009	170



Mesa cuadrada plegable. Teca de primera calidad terminación natural. **Sistema de plegado fácil.**



GT(cm)	TT(IN)	AL(cm)	FH(IN)
2,5	1,0	72,5	28,5
PN(kg)	NW(LB)	REF.(CODE)	PTOS (PT)
12,0	26,5	30100096	170



Mesa octogonal plegable. Teca de primera calidad terminación natural. **Sistema de plegado fácil.**



GT(cm)	TT(IN)	AL(cm)	FH(IN)
2,5	1,0	72,5	28,5
PN(kg)	NW(LB)	REF.(CODE)	PTOS (PT)
12,0	26,5	30100082	170



Mesa rectangular plegable. Teca de primera calidad terminación natural. **Sistema de plegado fácil.**



GT(cm)	TT(IN)	AL(cm)	FH(IN)
2,5	1,0	72,5	28,5
PN(kg)	NW(LB)	REF.(CODE)	PTOS (PT)
15,0	33,1	30100060	244



Mesa redonda plegable. Teca de primera calidad terminación natural. **Sistema de plegado fácil.**



GT(cm)	TT(IN)	AL(cm)	FH(IN)
2,5	1,0	72,5	28,5
PN(kg)	NW(LB)	REF.(CODE)	PTOS (PT)
14,0	30,9	30100118	218



Mesa octogonal plegable. Teca de primera calidad terminación natural. **Sistema de plegado fácil.**



GT(cm)	TT(IN)	AL(cm)	FH(IN)
2,5	1,0	72,5	28,5
PN(kg)	NW(LB)	REF.(CODE)	PTOS (PT)
21,0	46,3	30100095	252



Mesa redonda plegable. Teca de primera calidad terminación natural. **Sistema de plegado fácil.**



GT(cm)	TT(IN)	AL(cm)	FH(IN)
2,5	1,0	72,5	28,5
PN(kg)	NW(LB)	REF.(CODE)	PTOS (PT)
22,0	48,5	30100010	252



Carro bar de teca. Estructura en teca de primera calidad. Con dos bandejas y porta-bebidas. Ruedas de transporte.

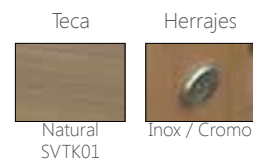

PN(KG)	NW(LB)	REF.(CODE)	PTOS (PT)
13,0	28,7	30600050	246



Mesa redonda con alas plegable. Estructura en teca de primera calidad. Sistema de plegado fácil.

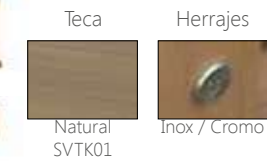

GT(CM)	TT(IN)	AL(CM)	FH(IN)
2,5	1,0	72,5	28,5
PN(KG)	NW(LB)	REF.(CODE)	PTOS (PT)
24,0	52,9	30100072	458

Medida plegada: 120 X 81 X 20 cm.



Taburete alto plegable. Estructura en teca de primera calidad. Herrajes en acabado inox. Requiere montaje.

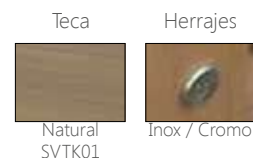

AA(CM)	SH(IN)	AB(CM)	AH(IN)	AE(CM)	FH(IN)
75,0	29,5			115,0	45,3
PN(KG)	NW(LB)	REF.(CODE)	PTOS (PT)		
8,0	17,6	30100111	188		



Barra de bar. Estructura en teca de primera calidad. Encimera y laterales plegables con sistema de cierre. Dispone de sistema de cierre y sistema de almacenaje y organización interior.



PN(KG)	NW(LB)	REF.(CODE)	PTOS (PT)
47,0	103,6	30600053	592

Medida plegada: 95 X 54 X 110 cm.



Tumbona modelo Presidencial. Teca de primera calidad con herrajes en latón. Respaldo multiposiciones. Cojinería (6cm) opcional. Plegable.



AA(CM)	SH(IN)	AR(CM)	BH(IN)	AB(CM)	AA(IN)
37,0	14,6	80-98	31,5-38,6	60,0	23,6
PN(KG)	NW(LB)	REF.(CODE)	PTOS (PT)		
17,0	37,5	30100078	314		

Cojín para tumbona Presidencial.

PN(KG)	NW(LB)	REF.(CODE)	PTOS (PT)
3,0	6,6	30400070	176



Tumbona modelo Banf. Teca de primera calidad con herrajes en latón. Se compone de dos piezas (Sillón + reposapiés). Cojinería (6cm) opcional. Requiere montaje.



AA(CM)	SH(IN)	AR(CM)	BH(IN)	AB(CM)	AA(IN)
37,0	14,6	87,0	34,3	60,0	23,6
PN(KG)	NW(LB)	REF.(CODE)	PTOS (PT)		
21,0	46,3	30100131	583		

Cojín para tumbona Banf.

PN(KG)	NW(LB)	REF.(CODE)	PTOS (PT)
3,6	7,9	30400088	250



Tumbona modelo Laguna. Teca de primera calidad con herrajes en latón. Respaldo y reposapiés regulables en 4 posiciones. Con bandeja extraíble. Cojinería (6cm) opcional. Requiere montaje.



AA(CM)	SH(IN)	AR(CM)	BH(IN)	AB(CM)	AA(IN)
33,5	13,2	33,5/91	13,2/35,8		
PN(KG)	NW(LB)	REF.(CODE)	PTOS (PT)		
30,0	66,1	30100081	532		

Cojín para tumbona Laguna

PN(KG)	NW(LB)	REF.(CODE)	PTOS (PT)
4,0	8,8	30400069	252



Tumbona modelo Vernom. Teca de primera calidad con herrajes en acero inoxidable. Respaldo regulable en 4 posiciones. Cojinería (6cm) opcional. Requiere montaje.



AA(CM)	SH(IN)	AR(CM)	BH(IN)	AB(CM)	AA(IN)
31,0	12,2	31/91	12,2/35,8		
PN(KG)	NW(LB)	REF.(CODE)	PTOS (PT)		
25,0	55,1	30100130	448		

Cojín para tumbona Vernom.

PN(KG)	NW(LB)	REF.(CODE)	PTOS (PT)
4,0	8,8	30400089	252



Sillón de comedor modelo Aurora. Estructura de aluminio y trenzado en rattan sintético de 8mm "Grey Ambiance". Cojín de asiento de 5cm color crudo. Alta resistencia a la intemperie.

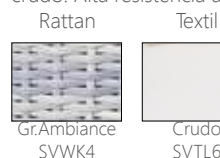

AA(cm)	SH(IN)	AB(cm)	AH(IN)	AE(cm)	FH(IN)
47,5	18,7	64,0	25,2	81,0	31,9
PN(kg)	NW(Lb)	REF.(CODE)	PTOS (PT)		
10,0	22,0	30200530	510		



Sofá de una plaza modelo Aurora. Estructura de aluminio y trenzado en rattan sintético de 8mm "grey Ambiance". Cojín de asiento (12cm) y respaldo (12cm) color crudo.

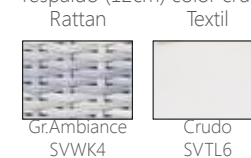

AA(cm)	SH(IN)	AB(cm)	AH(IN)	AE(cm)	FH(IN)
46,0	18,1	54,0	21,3	75,0	29,5
PN(kg)	NW(Lb)	REF.(CODE)	PTOS (PT)		
13,8	30,4	30200520	670		



Sofá de dos plazas modelo Aurora. Estructura de aluminio y trenzado en rattan sintético de 8mm "grey Ambiance". Cojín de asiento (12cm) y respaldo (12cm) color crudo.

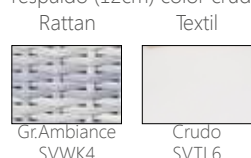

AA(cm)	SH(IN)	AB(cm)	AH(IN)	AE(cm)	FH(IN)
46,0	18,1	54,0	21,3	75,0	29,5
PN(kg)	NW(Lb)	REF.(CODE)	PTOS (PT)		
24,4	53,8	30200521	1212		



Modulo lateral brazo derecho modelo Aurora. Estructura de aluminio y trenzado en rattan sintético de 8mm "grey Ambiance". Cojín de asiento (12cm) y respaldo (12cm) color crudo.



AA(cm)	SH(IN)	AB(cm)	AH(IN)	AE(cm)	FH(IN)
46,0	18,1	55,0	21,7	75,0	29,5
PN(kg)	NW(Lb)	REF.(CODE)	PTOS (PT)		
20,8	45,9	30200535	1066		



Modulo lateral brazo izquierdo modelo Aurora. Estructura de aluminio y trenzado en rattan sintético de 8mm "grey Ambiance". Cojín de asiento (12cm) y respaldo (12cm) color crudo.

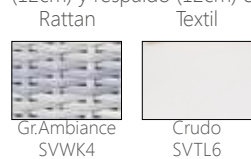

AA(cm)	SH(IN)	AB(cm)	AH(IN)	AE(cm)	FH(IN)
46,0	18,1	55,0	21,7	75,0	29,5
PN(kg)	NW(Lb)	REF.(CODE)	PTOS (PT)		
20,8	45,9	30200536	1066		



Modulo de ampliación modelo Aurora. Estructura de aluminio y trenzado en rattan sintético de 8mm "grey Ambiance". Cojín de asiento (12cm) y respaldo (12cm) color crudo.

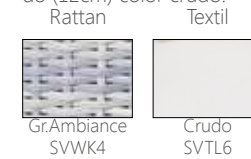

AA(cm)	SH(IN)	AB(cm)	AH(IN)	AE(cm)	FH(IN)
46,0	18,1			75,0	29,5
PN(kg)	NW(Lb)	REF.(CODE)	PTOS (PT)		
10,7	23,6	30200537	571		



Modulo de esquina modelo Aurora. Estructura de aluminio y trenzado en rattan sintético de 8mm "grey Ambiance". Cojín de asiento (12cm) y respaldo (12cm) color crudo.

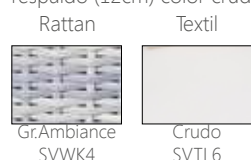

AA(cm)	SH(IN)	AB(cm)	AH(IN)	AE(cm)	FH(IN)
46,0	18,1			75,0	29,5
PN(kg)	NW(Lb)	REF.(CODE)	PTOS (PT)		
20,3	44,8	30200538	1398		



Daybed modelo Aurora. Estructura de aluminio y trenzado en rattan sintético de 8mm "grey Ambiance". Cojín de asiento (10cm) y respaldo (12cm) color crudo.

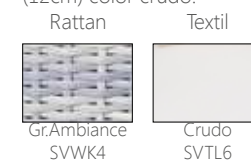

AA(cm)	SH(IN)	AR(cm)	BH(IN)	AB(cm)	AA(IN)
46,0	18,1	81,0	31,9		
PN(kg)	NW(Lb)	REF.(CODE)	PTOS (PT)		
18,7	41,2	30200533	1398		



Tumbona modelo Aurora. Estructura de aluminio y trenzado en rattan sintético de 8mm "grey ambiance". Cojín de asiento (8cm) y respaldo (12cm) color crudo.

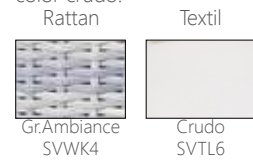

AA(cm)	SH(IN)	AR(cm)	BH(IN)	AB(cm)	AA(IN)
46,0	18,1	87,0	34,3		
PN(kg)	NW(Lb)	REF.(CODE)	PTOS (PT)		
20,7	45,6	30200523	1192		



Reposapiés modelo Aurora. Estructura de aluminio y trenzado en rattan sintético de 8mm "grey ambiance". Cojín color crudo (8cm).

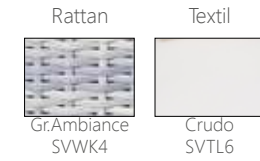

AA(cm)	SH(IN)	AB(cm)	AH(IN)	AE(cm)	FH(IN)
46,0	18,1			34,0	13,4
PN(kg)	NW(Lb)	REF.(CODE)	PTOS (PT)		
6,2	13,7	30200539	274		



Mesa de comedor redonda Aurora. Estructura de aluminio y trenzado en rattan sintético de 8mm "grey ambiance". Encimera en cristal cerámico de 5mm acabado "Grey wood". Requiere montaje.

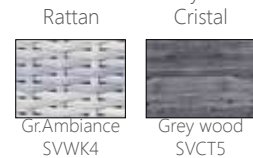

GT(cm)	TT(IN)	AL(cm)	FH(IN)
0,6	0,2	69,0	27,2
PN(kg)	NW(Lb)	REF.(CODE)	PTOS (PT)
31,4	69,2	30200531	1100



Mesa de comedor redonda Aurora. Estructura de aluminio y trenzado en rattan sintético de 8mm "grey ambiance". Encimera en cristal cerámico de 5mm acabado "Grey wood". Requiere montaje.

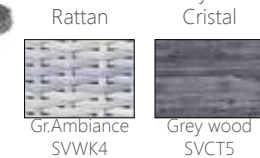

GT(cm)	TT(IN)	AL(cm)	FH(IN)
0,6	0,2	69,0	27,2
PN(kg)	NW(Lb)	REF.(CODE)	PTOS (PT)
40,0	88,2	30200532	1500

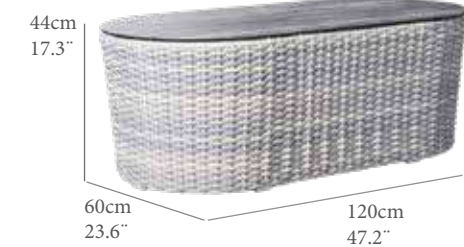

Mesa auxiliar modelo Aurora. Estructura de aluminio y trenzado en rattan sintético de 8mm "grey ambiance". Encimera en cristal cerámico de 5mm acabado "Grey wood".

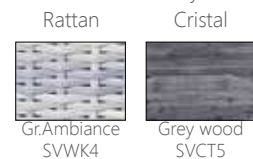

GT(cm)	TT(IN)	AL(cm)	FH(IN)
0,6	0,2		
PN(kg)	NW(Lb)	REF.(CODE)	PTOS (PT)
16,0	35,3	30200522	624



Mesa auxiliar redonda modelo Aurora. Estructura de aluminio y trenzado en rattan sintético de 8mm "grey ambiance". Encimera en cristal cerámico de 5mm acabado "Grey wood".

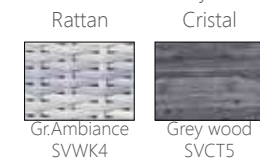

GT(cm)	TT(IN)	AL(cm)	FH(IN)
0,6	0,2		
PN(kg)	NW(Lb)	REF.(CODE)	PTOS (PT)
5,1	11,2	30200534	376



Rinconera Aurora 5 piezas. Compuesto de:

- 1 Lateral brazo (L). Referencia 30200536
- 1 Lateral brazo (R). Referencia 30200535
- 1 Modulo esquina. Referencia 30200538
- 1 Mod. Ampliación. Referencia 30200537
- 1 Mesa de centro. Referencia 30200522



Comedor Aurora 7 piezas. Compuesto de:
1 mesa de comedor. Referencia 30200532
6 Sillón de comedor. Referencia 30200530



Sofá de 1 plaza modelo Kurl. Estructura en aluminio color Greige, Cojin de asiento (8cm) y respaldo (10cm) color natural. Revestimiento en rattan plano de alta calidad. 82cm 32.3"



AA(CM)	SH(IN)	AB(CM)	AH(IN)	AE(CM)	FH(IN)
40,0	15,7			77,0	30,3
PN(KG)	NW(LB)	REF.(CODE)	PTOS (PT)		
18,0	39,7	30200741	1218		



Sofá de 2 plazas modelo Kurl. Estructura en aluminio color Greige. Cojin de asiento (8cm) y respaldo (10cm) color natural. Revestimiento en rattan plano de alta calidad.



AA(CM)	SH(IN)	AB(CM)	AH(IN)	AE(CM)	FH(IN)
40,0	15,7			77,0	30,3
PN(KG)	NW(LB)	REF.(CODE)	PTOS (PT)		
25,0	55,1	30200742	2044		



Daybed modelo Kurl. Estructura en aluminio color Greige, Cojin de asiento (8cm) y respaldo (10cm) color natural. Revestimiento en rattan plano de alta calidad.



AA(CM)	SH(IN)	AR(CM)	BH(IN)	AB(CM)	AA(IN)
40,0	15,7	40/82	15,7/32,3		
PN(KG)	NW(LB)	REF.(CODE)	PTOS (PT)		
45,5	100,3	30200744	2108		



Hamaca modelo Kurl. Estructura en aluminio color Greige y cojineria (8cm) color natural. Revestimiento en rattan plano de alta calidad. Respaldo multiposición.



AA(CM)	SH(IN)	AR(CM)	BH(IN)	AB(CM)	AA(IN)
40,0	15,7	40/82	15,7/32,3		
PN(KG)	NW(LB)	REF.(CODE)	PTOS (PT)		
19,0	41,9	30200745	1144		



Mesa de centro modelo Kurl. Estructura en aluminio color Greige. Encimera en cristal templado de 5mm color Greige. Revestimiento en rattan plano de alta calidad.



GT(CM)	TT(IN)	AL(CM)	FH(IN)
0,5	0,2		
PN(KG)	NW(LB)	REF.(CODE)	PTOS (PT)
13,0	28,7	30200743	720



Mesa de auxiliar Kurl. Estructura en aluminio color Greige. Encimera en cristal templado de 5mm color Greige. Revestimiento en rattan plano de alta calidad.



GT(CM)	TT(IN)	AL(CM)	FH(IN)
0,5	0,2		
PN(KG)	NW(LB)	REF.(CODE)	PTOS (PT)
7,0	15,4	30200746	310



Macetero decorativo modelo Kurl. Estructura en aluminio color Greige. Revestimiento en rattan plano de alta calidad.



PN(KG)	NW(LB)	REF.(CODE)	PTOS (PT)
2,0	4,4	30200747	212



Cubo musical modelo Kurl. Estructura en polipropileno. Sistema de cambio de color RGB al ritmo musical. Sistema Bluetooth 4.1 con altavoz de 10W. IP44. Carga por USB. Batería Li-ion.



PN(KG)	NW(LB)	REF.(CODE)	PTOS (PT)
3,0	6,6	30200748	298



Daybed modelo Arvika. Estructura de aluminio color blanco. Trenzado artesanal en rattan sintético "Half moon pure white" combinado. Cojín de asiento (7cm) crudo y respaldo (16cm) Taupe combinada.



AA(cm)	SH(IN)	AR(cm)	BH(IN)	AB(cm)	AA(IN)
42,0	16,5	90,0	35,4		
PN(kg)	NW(LB)	REF.(CODE)	PTOS (PT)		
28,6	63,1	30200609	1934		



Sofá Alto modelo Aven. Estructura de aluminio color blanco. Trenzado artesanal en rattan sintético redondo y plano combinado. Cojín de asiento (6cm) crudo y respaldo(16cm) Taupe combinado.

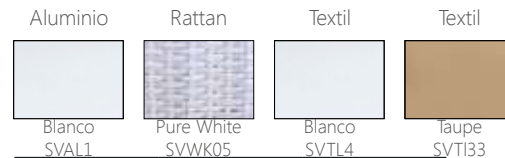

AA(cm)	SH(IN)	AB(cm)	AH(IN)	AE(cm)	FH(IN)
38,0	15,0			123,0	48,4
PN(kg)	NW(LB)	REF.(CODE)	PTOS (PT)		
8,3	18,3	30200600	454		

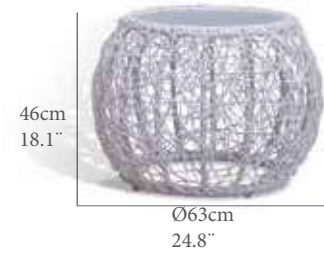

Mesa auxiliar modelo Aven. Estructura de aluminio color blanco. Trenzado artesanal en rattan sintético redondo y plano combinado. Encimera en cristal templado de 5mm color Blanco puro mate.

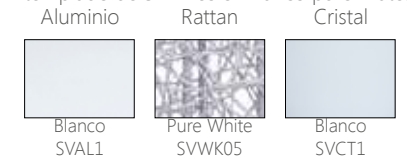

GT(cm)	TT(IN)	AL(cm)	FH(IN)
PN(kg)	NW(LB)	REF.(CODE)	PTOS (PT)
4,6	10,1	30200601	170



Balancín modelo Arvika. Estructura de acero color blanco. Trenzado artesanal en rattan sintético plano de 6mm. Cojín color gris jaspeado. Requiere montaje



AA(cm)	SH(IN)	AB(cm)	AH(IN)	AE(cm)	FH(IN)
55-60	21,6-23,6			199,0	78,3
PN(kg)	NW(LB)	REF.(CODE)	PTOS (PT)		
31,9	70,3	30200613	1110		



Mesa auxiliar modelo Arvika. Estructura de aluminio color blanco. Trenzado artesanal en rattan sintético "Half moon white" de 6mm. Encimera en cristal templado de 5mm color Blanco puro mate.

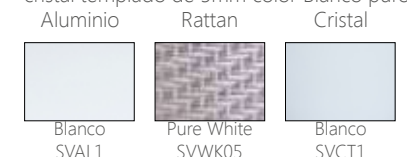

GT(cm)	TT(IN)	AL(cm)	FH(IN)
PN(kg)	NW(LB)	REF.(CODE)	PTOS (PT)
5,2	11,5	30200610	320



Sillón relax modelo Melbourne. Estructura de aluminio y trenzado en rattan sintético de 6mm "Ice grey". Cojines de asiento de 10cm color gris. Alta resistencia a la intemperie.



AA(cm)	SH(IN)	AB(cm)	AH(IN)	AE(cm)	FH(IN)
48,0	18,9	66,0	26,0	115,5	45,5
PN(kg)	NW(LB)	REF.(CODE)	PTOS (PT)		
32,9	72,4	39600099	822		



Mesa auxiliar modelo Melbourne. Estructura de aluminio y trenzado en rattan sintético de 6mm "Ice grey". Encimera en cristal templado de 5mm. Alta resistencia a la intemperie.



GT(cm)	TT(IN)	AL(cm)	FH(IN)
5,2	11,4	39600100	242



Tumbona Melbourne. Estructura de aluminio y trenzado rattan sintético de 6mm "Ice grey". Cojinería de 10cm color gris. Respaldo regulable en 4 posiciones. Con ruedas de transporte.



AA(cm)	SH(IN)	AR(cm)	BH(IN)	AB(cm)	AA(IN)
40,0	15,7	40/110	15,7/43,3	55,0	21,7
PN(kg)	NW(LB)	REF.(CODE)	PTOS (PT)		
17,3	38,1	30200229	1070		



Sofá 1 plaza modelo Seattle. Estructura de aluminio y trenzado en rattan sintético de 5mm "Grey light". Cojín de asiento (6cm) y respaldo (12cm) gris claro. Patas en aluminio pintado a mano.



AA(cm)	SH(IN)	AB(cm)	AH(IN)	AE(cm)	FH(IN)
38,0	15,0	58,0	22,8	74,0	29,1
PN(kg)	NW(LB)	REF.(CODE)	PTOS (PT)		
8,0	17,6	39600021	452		



Sofá 2 plazas modelo Seattle. Estructura de aluminio y trenzado en rattan sintético de 5mm "Grey light". Cojín de asiento (6cm) y respaldo (12cm) gris claro. Patas en aluminio pintado a mano.



AA(cm)	SH(IN)	AB(cm)	AH(IN)	AE(cm)	FH(IN)
38,0	15,0	58,0	22,8	74,0	29,1
PN(kg)	NW(LB)	REF.(CODE)	PTOS (PT)		
14,0	30,9	39600022	700		



Mesa auxiliar modelo Seattle. Estructura de aluminio pintado a mano efecto madera y trenzado en rattan sintético de 6mm "Grey light". Encimera en cristal templado de 5mm Traslucido.



GT(cm)	TT(IN)	AL(cm)	FH(IN)
0,5	0,2		
PN(kg)	NW(LB)	REF.(CODE)	PTOS (PT)
12,0	26,5	39600023	230



Sillón de comedor Palma. Estructura de aluminio y trenzado en rattan sintético combinado de 6-25mm "Cool white". Cojín de asiento y respaldo de 5cm color gris claro..Alta resistencia a la intemperie.
Rattan Textil



AA(cm)	SH(IN)	AB(cm)	AH(IN)	AE(cm)	FH(IN)
45,5	17,9	64,0	25,2	89,0	35,0
PN(kg)	NW(LB)	REF.(CODE)	PTOS (PT)		
6,9	15,2	30200233	400		



Sofá 1 plaza Palma. Estructura de aluminio y trenzado en rattan sintético combinado de 6-25mm "Cool white". Cojín de asiento(10cm) y respaldo(12cm) gris claro.



AA(cm)	SH(IN)	AB(cm)	AH(IN)	AE(cm)	FH(IN)
43,5	17,1	64,0	25,2	81,0	31,9
PN(kg)	NW(LB)	REF.(CODE)	PTOS (PT)		
8,7	19,2	39600024	620		



Sofá 3 plazas Palma. Estructura de aluminio y trenzado en rattan sintético combinado de 6-25mm "Cool white". Cojín de asiento(10cm) y respaldo(12cm) gris claro.



AA(cm)	SH(IN)	AB(cm)	AH(IN)	AE(cm)	FH(IN)
43,5	17,1	64,0	25,2	81,0	31,9
PN(kg)	NW(LB)	REF.(CODE)	PTOS (PT)		
19,3	42,5	39600025	1324		



Mesa de comedor Palma. Estructura de aluminio y trenzado en rattan sintético combinado de 6-25mm "Cool white". encimera en cristal templado de 5mm traslucido..Alta resistencia a la intemperie.
Rattan Cristal



GT(cm)	TT(IN)	AL(cm)	FH(IN)
0,5	0,2	69,0	27,2
PN(kg)	NW(LB)	REF.(CODE)	PTOS (PT)
31,0	68,3	30200232	688



Mesa auxiliar Palma. Estructura de aluminio y trenzado en rattan sintético combinado de 6-25mm "Cool white". encimera en cristal templado de 5mm traslucido..Alta resistencia a la intemperie.
Rattan Cristal



GT(cm)	TT(IN)	AL(cm)	FH(IN)
0,5	0,2	38,0	15,0
PN(kg)	NW(LB)	REF.(CODE)	PTOS (PT)
10,7	23,6	39600026	332



Mesa auxiliar Palma. Estructura de aluminio y trenzado en rattan sintético combinado de 6-25mm "Cool white". encimera en cristal templado de 5mm traslucido..Alta resistencia a la intemperie.
Rattan Cristal



GT(cm)	TT(IN)	AL(cm)	FH(IN)
0,5	0,2	69,0	27,2
PN(kg)	NW(LB)	REF.(CODE)	PTOS (PT)
5,2	11,4	30200341	278

40cm
15.7"



Tumbona Palma. Estructura de aluminio y trenzado en rattan sintético combinado 6-25mm "Cool white". Cojín de 10cm gris. Respaldo regulable en 4 posiciones. Con ruedas de transporte.
Rattan Textil



AA(cm)	SH(IN)	AR(cm)	BH(IN)	AB(cm)	AA(IN)
40,0	15,7	40/110	15,7/43,3	55,0	21,7
PN(kg)	NW(LB)	REF.(CODE)	PTOS (PT)		
17,3	38,1	30200228	1070		



Sillón de comedor Riviera. Estructura de aluminio y trenzado en rattan sintético de 6mm "Natural Feel". Cojín de asiento de 5cm color gris claro.. Alta resistencia a la intemperie

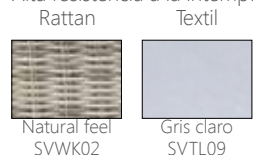

AA(CM)	SH(IN)	AB(CM)	AH(IN)	AE(CM)	FH(IN)
49,0	19,3	66,0	26,0	96,0	37,8
PN(KG)	NW(LB)	REF.(CODE)	PTOS (PT)		
7,9	17,4	30200240	460		



Sofá de 1 plaza modelo New Berlin. Estructura de aluminio y trenzado en rattan sintético de 6mm "Natural feel". Cojín de asiento Y respaldo de 12cm color gris claro.

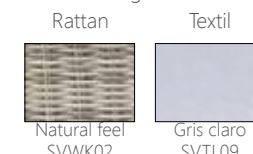

AA(CM)	SH(IN)	AB(CM)	AH(IN)	AE(CM)	FH(IN)
44,0	17,3	62,0	24,4	85,0	33,5
PN(KG)	NW(LB)	REF.(CODE)	PTOS (PT)		
10,9	24,0	39600114	234		



Sillón giratorio Riviera. Estructura de aluminio y trenzado en rattan sintético de 6mm "Natural Feel". Cojín de asiento (10cm) y respaldo (12cm) color gris claro. Alta resistencia a la intemperie.

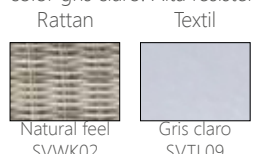

AA(CM)	SH(IN)	AB(CM)	AH(IN)	AE(CM)	FH(IN)
46,0	18,1	67,0	26,4	86,0	33,9
PN(KG)	NW(LB)	REF.(CODE)	PTOS (PT)		
27,1	59,7	30200237	346		



Sofá de 3 plazas modelo New Berlin. Estructura de aluminio y trenzado en rattan sintético de 6mm "Natural feel". Cojín de asiento Y respaldo de 12cm color gris claro.

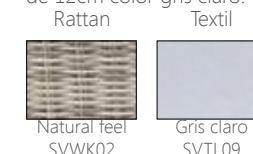

AA(CM)	SH(IN)	AB(CM)	AH(IN)	AE(CM)	FH(IN)
44,0	17,3	62,0	24,4	85,0	33,5
PN(KG)	NW(LB)	REF.(CODE)	PTOS (PT)		
23,3	51,4	39600115	1040		



Mesa de comedor cuadrada Riviera. Estructura de aluminio y trenzado en rattan sintético de 6mm "Natural feel". Encimera en cristal templado de 5mm. Alta resistencia a la intemperie.



GT(CM)	TT(IN)	AL(CM)	FH(IN)
0,5	0,2	69,0	27,2
PN(KG)	NW(LB)	REF.(CODE)	PTOS (PT)
17,6	38,8	30200253	558



Mesa de comedor rectangular Riviera. Estructura de aluminio y trenzado en rattan sintético de 6mm "Natural feel". Encimera en cristal templado de 5mm. Alta resistencia a la intemperie.



GT(CM)	TT(IN)	AL(CM)	FH(IN)
0,5	0,2	69,0	27,2
PN(KG)	NW(LB)	REF.(CODE)	PTOS (PT)
28,1	61,9	30200252	392



Mesa de comedor rectangular Riviera. Estructura de aluminio y trenzado en rattan sintético de 6mm "Natural feel". Encimera en cristal templado de 5mm. Alta resistencia a la intemperie.



GT(CM)	TT(IN)	AL(CM)	FH(IN)
0,5	0,2	69,0	27,2
PN(KG)	NW(LB)	REF.(CODE)	PTOS (PT)
36,0	79,4	30200241	904



Mesa alta modelo New Berlin. Estructura de aluminio y trenzado en rattan sintético de 6mm "Natural feel". Encimera en cristal templado de 5mm traslucido. Requiere montaje.



GT(CM)	TT(IN)	AL(CM)	FH(IN)
0,5	0,2	60,0	23,6
PN(KG)	NW(LB)	REF.(CODE)	PTOS (PT)
25,1	55,3	39600116	496



-Sistema relax



105cm
41.3"

90cm
35.4"

83cm
32.7"

Sillón relax modelo Riviera. Estructura de aluminio y trenzado en rattan sintético de 6mm "Natural feel". Cojines de asiento de 12cm color gris. Alta resistencia a la intemperie. Reclinable.

Rattan Textil



Natural feel
SVWK02



Gris claro
SVTL09

AA(cm)	SH(IN)	AB(cm)	AH(IN)	AE(cm)	FH(IN)
45,0	17,7	61,5	24,2	100,0	39,4
PN(kg)	NW(LB)	REF.(CODE)	PTOS (PT)		
16,3	35,8	39600027	842		



-Convertible en mesa
-Respaldos reclinables.



105cm
41.3"

90cm
35.4"

203cm
79.9"

Sofá relax modelo Riviera. Estructura de aluminio y trenzado en rattan sintético de 6mm "Natural feel". Cojines de 12cm color gris. Respaldos laterales reclinables y central convertible en mesa.

Rattan Textil



Natural feel
SVWK02

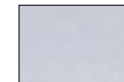

Gris claro
SVTL09

AA(cm)	SH(IN)	AB(cm)	AH(IN)	AE(cm)	FH(IN)
45,0	17,7	61,5	24,2	100,0	39,4
PN(kg)	NW(LB)	REF.(CODE)	PTOS (PT)		
35,5	78,3	39600028	1836		



-Elevable



44cm
17.3"

55cm
21.6"

105cm
41.3"

Mesa rectangular modelo Riviera. Estructura de aluminio y trenzado en rattan sintético de 8mm "grey ambiance". Encimera en cristal templado de 5mm traslucido. Encimera Elevable.

Rattan Cristal



Natural feel
SVWK02



Traslucido

GT(cm)	TT(IN)	AL(cm)	FH(IN)		
22,3	49,2	39600029	602		



40cm
15.7"

39cm
15.3"

39cm
15.3"

Puff reposapiés modelo New Berlin. Estructura de aluminio y trenzado en rattan sintético de 6mm "Natural feel". Cojín de 8cm color gris claro.

Rattan Textil



Natural feel
SVWK02



Gris claro
SVTL09

AA(cm)	SH(IN)	AB(cm)	AH(IN)	AE(cm)	FH(IN)
40,0	15,7				
PN(kg)	NW(LB)	REF.(CODE)	PTOS (PT)		
2,5	5,4	39600117	146		



65cm
25.6"

Ø105cm
41.3"

Mesa auxiliar redonda Riviera. Estructura de aluminio y trenzado en rattan sintético de 6mm "Natural feel". Encimera en cristal templado de 5mm. Alta resistencia a la intemperie.

Rattan Cristal



Natural feel
SVWK02



Traslucido

GT(cm)	TT(IN)	AL(cm)	FH(IN)		
0,5	0,2	50,0	19,7		
PN(kg)	NW(LB)	REF.(CODE)	PTOS (PT)		
18,5	40,8	30200238	622		

COLECCIÓN ALUMINIO / ALUMINIUM COLLECTION

Aluminio

Blanco SVAL1

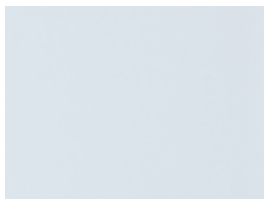

Arce SVAL2



Taupe SVAL3



Antracita SVAL4



Aguamarina SVAL5



Verde Oliva SVAL6



Textilene

Blanco SVTX1



Gris Claro SVTX2



Arce SVTX3



Gris Antra SVTX4

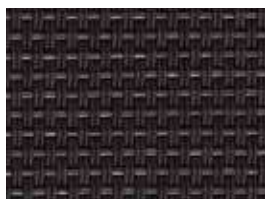

Taupe SVTX5

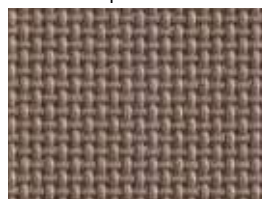

Cuerda

Olefina gris claro SVCR01



Olefina Taupe SVCR02



Olefina antracita SVCR03



Textil

Gris claro SVTL05

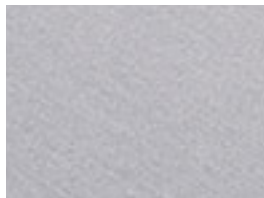

Taupe SVTL07



Gris tempo SVTX09



Nautico blanco SVTL01

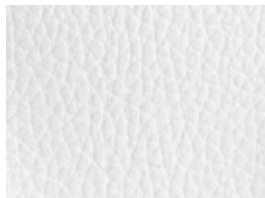

Blanco cartenza SVTL02



Arce cartenza SVTL03



Blanco Stryn SVTL11



Gris Stryn SVTL12

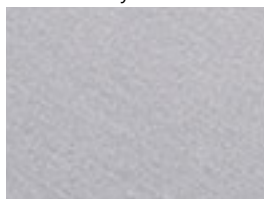

Blanco SVTL04

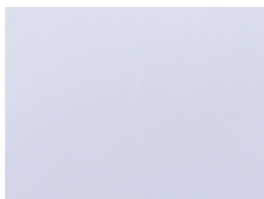

Gris claro SVTL05



Gris claro B SVTL20



Cristal

Blanco SVCT01

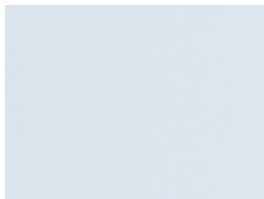

Arce SVCT02

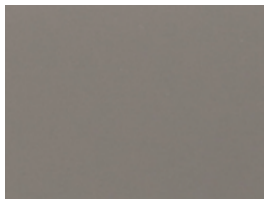

Taupe SVCT03



Gris claro SVCT05



Greywood SVCT05



Antracita SVCT06



Cerámico Granit SVCT10



Polywood

Gris SVPW01



Cuerda

Antracita SVCR04



Gris SVCR05

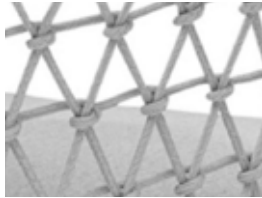

Gris acero SVCR06



Antracita SVCR07



Greige SVCR11



Blanca (G.hind)



TAupe SVCR08

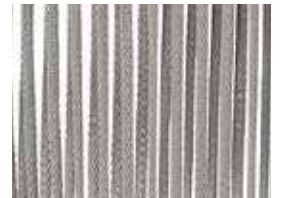

Blanco SVCR10



Gris claro SVCR09



Aluminio

Gris antracita SVAL04



Light grey SVAL08



Blanco SVAL1

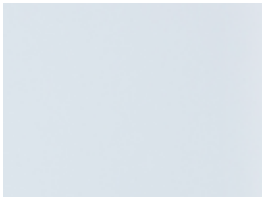

Greige SVAL09

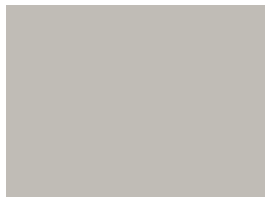

Taupe SVAL03



Cristal

Ceramic antracita SVCT11"



Blanco SVCT01

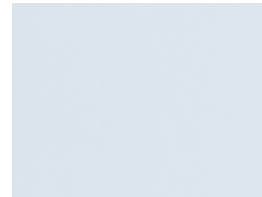

Ceram. Blanco SVCT14"



Ceramic SVCT12"



Ceramic "Granit" SVCT13



Antracita SVCT06

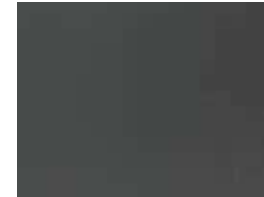

Old marbre SVCT16



Gris acero SVCT15



Textil

Gris medio SVTL21



Gris claro SVTL22



Gris Jaspeado A SVTL25



Gris Jaspeado B SVTL23



Gris Profundo SVTL24

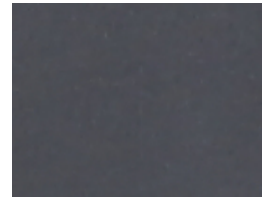

Gris claro SVTL20

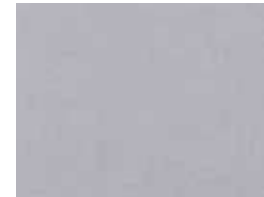

Gris claro SVTL32



Marine grey SVTL31



Taupe SVTL26



Gris medio SVTL27



Gris acero SVTL28



Gris amatista SVTL229



Gris fluorita SVTL30

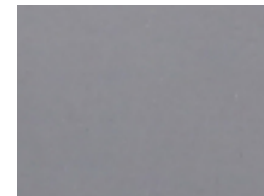

COLECCIÓN RATÁN SINTÉTICO / WICKER COLLECTION

Rattan

Grey wash SVWK06



Grey ambiance SVWK04



Pure white SVWK05 (A)



Pure white SVWK05 (B)



Pure white SVWK05 (C)



Ice grey SVWK01



Grey light



Natural Feel SVWK02



Cool White SVWK03



Textil

Natural SVTL35



Crudo SVTL06

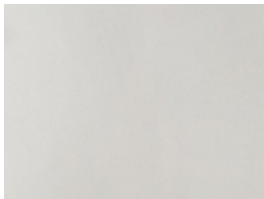

Blanco SVTL04



Taupe SVTL33



Gris SVTL10



Gris claro SVTL09

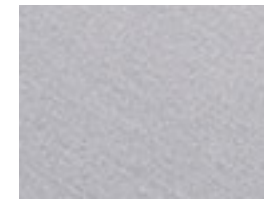

Aluminio

Greige SVAL09



Blanco SVAL01

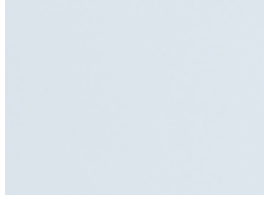

Grey wood SVAL10



Cristal

Greige SVCT17



Greywood SVCT05



Blanco SVCT01

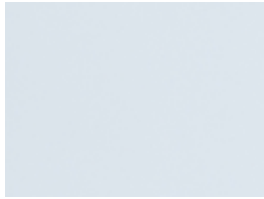

Traslucido



Teca

Natural SVTK01



White wash SVTK02



COLECCIÓN TECA / TEAK COLLECTION

Textil

Blanco cloud SVTL15

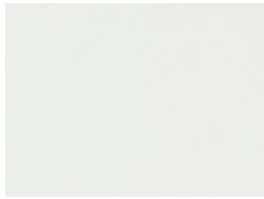

Crudo SVTL14



Textilene

Batyline blanco SVTX07

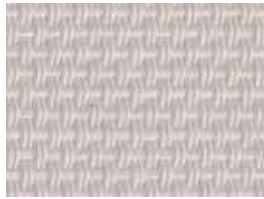

Batyline negro SVTX06

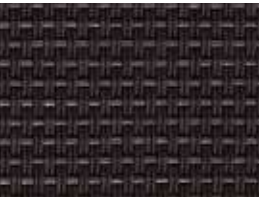



Condiciones Generales de Venta

Condiciones de envío: Portes pagados en pedidos superiores a 400€ netos (IVA no incluido) para península y baleares (Salvo Formentera, consultar condiciones). Para pedidos no superiores a 400€ se aplicará un porte fijo de 20€+IVA que incluiremos en albarán por pedido.

Otros países consultar condiciones.

La mercancía se entregará desde nuestros almacenes de Silla (Valencia). Cualquier anomalía deberá ser reclamada a la recepción de la mercancía, y haciéndola constar en el parte del transportista o albarán de recepción **en un plazo máximo de 24 horas**. Dicha incidencia se comunicará a Sunnyval garden & contract (Coval maquinaria S.A.) inmediatamente. De no ser así, Coval se exime de toda responsabilidad por daños de transporte. No se aceptará ninguna reclamación causada por transporte sin fotografías de la incidencia y del embalaje en mal estado.

Las entregas realizadas fuera de las instalaciones habituales de entrega, siempre se realizarán a pie de calle, y se aplicará un recargo del 5% en el precio tarifa del producto.

Devolución de mercancía: Cualquier devolución deberá ser aceptada previamente por Coval. En un plazo que no exceda los 30 días, se admitirán devoluciones de artículos no usados ni montados y únicamente en su embalaje original. **Los gastos de devolución serán a cargo del cliente.** En ningún caso se aceptará la devolución de muebles cuyo montaje haya sido iniciado. Al producirse las devoluciones Coval emitirá un albarán de abono que se liquidará en próximas facturas.

Garantía general del producto: La garantía General de todos los productos del catálogo es de 2 años desde la fecha de entrega al usuario final. La garantía solo cubre defectos de fabricación y no del uso o desgaste normal del producto así como de su mala utilización o falta de protección a condiciones climatológicas extremas o periodos prolongados de desuso.

Toda reclamación de garantía deberá ser cursada adjuntando el parte de incidencia y fotos de la misma vía email. Una vez aceptada se recogerá en las instalaciones del cliente siendo los gastos de devolución a cargo de Sunnyval, y pasará a ser reparada por el equipo técnico de Sunnyval. De no ser posible, se procederá al cambio. Coval se reserva el derecho de realizar el cambio directo del artículo en garantía sin proceder a la recogida del artículo defectuoso.

La cojinería de serie incluida en los productos no tiene garantía por decoloración ya que los pigmentos de la tela se aclaran u oscurecen con el paso del tiempo. La cojinería a medida de gama especial cuenta con dos años de garantía frente a decoloración de grado superior al 10%. No se atenderá en garantía la aparición de pequeñas grietas en madera de teca siempre y cuando no afecten a la estructura y seguridad del mueble, siendo la aparición de estas totalmente normal en el tiempo. No se aceptará como garantía muebles de wicker con fibras rotas los cuales no hayan sido debidamente protegidos en periodos prolongados de desuso.

Tarifa válida salvo error tipográfico. Nos reservamos el derecho a introducir modificaciones en el diseño o en los precios de este catálogo. Imágenes cedidas por los fabricantes de producto. En base a las imágenes de este catálogo no se pueden hacer valer derechos. Precios válidos hasta fin de existencias o actualización de tarifa. Algunos datos técnicos son aproximados.

Ante cualquier controversia, los tribunales competentes serán los de Valencia. **ENERO 2023**



Terms of Sale

Shipping terms: Freight paid on orders over € 400 net (VAT not included) for the peninsula and the Balearic Islands (Except Formentera, check terms). For orders not exceeding € 350 a fixed charge of € 20 + VAT will be applied that we will include on the delivery note.

Other countries consult terms

The merchandise will be delivered from our warehouses in Silla (Valencia). Any anomaly must be claimed upon receipt of the merchandise, and stating it on the part of the carrier or receipt within a maximum period of 24 hours. Said incident will be communicated to Sunnyval garden & contract (Coval Maquinaria S.A.) immediately. If not, Coval disclaims all liability for transport damage. Any claim caused by transport without photographs of the incident and of the packaging in poor condition will not be accepted.

Return of merchandise: Any return must be previously accepted by Coval. In a period not exceeding 30 days, returns of items not used or assembled and in their original packaging will be accepted. The return costs will be borne by the customer. In no case will the return of furniture whose assembly has been initiated be accepted. When the returns are made, Coval will issue a credit invoice that will be settled in future invoices.

Deliveries made outside of a customer's usual delivery facilities will always be made at street level, and will incur a 5% surcharge in the price of the product.

General guarantee of the product: The General guarantee of all products in the catalog is 2 years from the date of delivery to the end user. The guarantee only covers manufacturing defects and not the normal use or wear of the product as well as its bad use or lack of protection to extreme weather conditions or prolonged periods of disuse.

All warranty claims must be submitted attaching the incident and photos of the same via email. Once accepted, it will be collected at the client's facilities, with the return costs borne by Coval and repaired by the Sunnyval technical team. If this is not possible, we will proceed to the change. Coval reserves the right to make the direct change of the article in warranty without proceeding to the collection of the defective article.

The standard cushion included in the sets is not guaranteed by discoloration since the pigments of the fabric become lighter or darker with the passage of time. The custom-made cushion of special range has a two-year warranty against discoloration of more than 10%. The appearance of small cracks in teak wood will not be taken into warranty as long as they do not affect the structure and safety of the furniture. The appearance of these totally normal over time. Wicker furniture with broken fibers which have not been properly protected in prolonged periods of disuse will not be accepted as warranty.

Valid prices except typographical error. We reserve the right to make changes to the design or prices of this catalog. Images provided by product manufacturers. No rights can be asserted based on the images in this catalog. Prices valid until end of stock. Some technical data are approximate.

In case of any dispute, the competent courts will be those of Valencia. **JANUARY 2023**



COVAL S.A.
Avenida Espioca nº85
46460 Silla
Valencia
Tel: (+34) 96 121 08 91
info@sunnyval.eu
jardin@coval.es